



# **MODEL 5204**

**Fire Control/Communicator**

**Installation and  
Operation Manual**

**Part Number 150644D, 6/01**

---

# Content

---

---

## Section 1

### Introduction ..... 1-1

---

- 1.1 How to Use This Manual ..... 1-1
- 1.2 Optional Accessories ..... 1-2

## Section 2

### Specifications and System Planning ..... 2-1

---

- 2.1 Electrical Specifications ..... 2-1
- 2.2 Environmental Specifications ..... 2-1
- 2.3 Wiring Specifications ..... 2-2

## Section 3

### Agency Listings, Approvals, and Requirements ..... 3-1

---

- 3.1 Federal Communications Commission (FCC) ..... 3-1
  - 3.1.1 FCC Warning ..... 3-1
- 3.2 Underwriters Laboratories (UL) ..... 3-2
  - 3.2.1 Requirements for All Installations ..... 3-2
  - 3.2.2 Requirements for Central Station Fire Alarm Systems ..... 3-2
  - 3.2.3 Requirements for Local Protected Fire Alarm Systems ..... 3-3
  - 3.2.4 Requirements for Auxiliary Protected Fire Alarm Systems for Fire Alarm Service ..... 3-3
  - 3.2.5 Requirements for Remote Station Protected Fire Alarm Systems - Polarity Reversal ..... 3-3
- 3.3 California Fire Marshal (CFM) ..... 3-4
- 3.4 Factory Mutual (FM) ..... 3-4
- 3.5 Materials & Equipment Board of Acceptance (MEA) ..... 3-4

## Section 4

### Installation Overview ..... 4-1

---

- 4.1 Model 5204 Wiring Diagram ..... 4-1
- 4.2 Current Draw Worksheet ..... 4-2
  - 4.2.1 Worksheet Example ..... 4-3
  - 4.2.2 Worksheet Requirements ..... 4-4

## Section 5

### Control Panel Installation ..... 5-1

---

- 5.1 Grounding the Model 5204 Cover ..... 5-2
- 5.2 Smoke Power Selection ..... 5-2
- 5.3 Power Supply Wiring ..... 5-2
- 5.4 Battery Connection ..... 5-3

5.5	Mounting the 5204 .....	5-3
5.6	Terminal Strip Description .....	5-3
5.7	Model 5205 Dialer and Telephone Line Connection (Optional) .....	5-5
	Installation .....	5-5
	Ring Detect Circuit .....	5-6
5.8	Cable Connectors .....	5-7
	Status (P1) .....	5-7
	Model 5230 (P2) .....	5-7
	Power Supply (AC) Connector (P4) .....	5-7

## Section 6

### Compatible Product Installation ..... 6-1

---

6.1	Zone Wiring .....	6-1
6.1.1	Four-Wire Smoke Detector Connection .....	6-2
6.1.2	Two-Wire Smoke Detector Connection .....	6-3
	Notes for Both Tables .....	6-3
6.2	Connections to Compatible Silent Knight Products .....	6-6
6.2.1	Model 4180 Status Display Module .....	6-6
6.2.2	Model 5220 Direct Connect Module .....	6-7
	6.2.2.1 Installation .....	6-8
	6.2.2.2 City Box Connect (24 VDC Systems Only) .....	6-8
	6.2.2.3 NFPA 72 Polarity Reversal (12 or 24 VDC Systems) .....	6-9
6.2.3	Model 5230 Remote Annunciator .....	6-9
	6.2.3.1 Setting ID Codes .....	6-9
	6.2.3.2 Wiring the 5230 Remote Annunciator .....	6-10
	6.2.3.3 Mounting the 5230 Remote Annunciator .....	6-11
6.2.4	Model 5395 Distributed Power Module .....	6-11
6.2.5	Model 7181 Zone Converter .....	6-12
6.3	Supervised Notification Device Outputs .....	6-13
6.4	Auxiliary Relays .....	6-20
6.5	External Silence Keyswitch (Optional) .....	6-21

## Section 7

### Normal Operation ..... 7-1

---

7.1	Built-in Touchpad and Model 5230 Annunciator Operation .....	7-2
7.1.1	Operating Modes .....	7-5
7.1.2	Built-in Touchpad Display Codes .....	7-5
7.1.3	Silencing the System .....	7-7
7.1.4	LED Indicators .....	7-7
7.2	System Testing .....	7-8
7.2.1	Fire Drills (Mode 20) .....	7-8
7.2.2	Walk Test (Mode 22) .....	7-8
7.2.3	Automatic Self Test .....	7-8
7.2.4	Watchdog Circuit .....	7-8
7.3	Zone Characteristics .....	7-9
7.3.1	Zone Type .....	7-9
7.3.2	Cross Alarm .....	7-10
	Example .....	7-10
7.3.3	Pre-Alarm .....	7-11
7.3.4	Smoke Verification .....	7-12
7.3.5	Zone Response Time .....	7-13

## **Section 8 Programming** ..... 8-1

---

8.1	EEPROM Information .....	8-1
8.2	Downloading .....	8-2
8.3	How to Use Step Programming .....	8-2
8.3.1	Entering Step Programming (Mode 27) .....	8-3
8.3.2	Programming Options .....	8-3
8.3.3	Advancing to the Next Option .....	8-4
8.3.4	Going to a Specific Step .....	8-4
8.3.5	Viewing Previously Programmed Data .....	8-5
8.3.6	Correcting Errors .....	8-5
8.3.7	Entering Hexadecimal Digits .....	8-5
8.3.8	Programming Examples .....	8-6
	Example 1: Choosing a Programming Option from a Menu .....	8-6
	Example 2: Programming Location Description Names .....	8-6
8.3.9	Exiting Step Programming .....	8-7
8.4	Step Programming Options .....	8-8
8.4.1	Programming Steps .....	8-8

## **Section 9 Troubleshooting** ..... 9-1

---

9.1	Silencing Notification Devices .....	9-1
9.2	Earth Ground Fault Troubleshooting .....	9-1
9.2.1	P3 and P4 Fault .....	9-1
9.2.2	Accu-Zone, Troubleshooting (Mode 25) .....	9-2
	Special Notes .....	9-3
9.3	Troubleshooting and System Messages .....	9-4

## **Section 10 Central Station Reporting** ..... 10-1

---

10.1	Power Loss Reporting .....	10-1
10.2	Reporting Formats .....	10-1
10.2.1	SIA Format Printed Messages .....	10-2
10.2.2	Silent Knight 3/1 and Sescoa 3/1 Formats .....	10-3
10.2.3	Silent Knight FSK and 4+2 Formats .....	10-4
10.2.4	Radionics BFSK Format .....	10-5

## **Appendix A Programming Quick Reference** ..... A-1

---



---

# Section 1

## Introduction

---

---

The Model 5204 is a low-cost fire alarm control panel with optional communicator that meets UL 864 and NFPA 72 requirements. It is available with a 12 or 24 VDC power supply, which you can select in the field. The 5204 cabinet can be surface mounted or flush mounted.

### 1.1 How to Use This Manual

---

The Model 5204 Fire Control/Communicator Installation Manual (P/N 150644) is intended for those people involved with the installation, maintenance, and programming of the 5204 panel. It covers wiring, connection to compatible products, normal operation, programming, troubleshooting, and central station reporting.

This manual is a comprehensive guide. It provides detailed instructions and can be used for reference. The installation manual is organized chronologically by the tasks that need to be performed to get the panel operating according to your needs. You can skip sections that do not apply to your installation.

In this manual, the following conventions are used:

ENTER or 

Represents a key that you press on a touchpad.



Shaded displays represent messages that you see on the built-in touchpad (7-segment) light emitting diode (LED) display.

SMOKE RESET TIME

Words typed in this font represent messages that you see on a liquid crystal display (LCD).

## 1.2 Optional Accessories

---

The following Silent Knight components can be used with the Model 5204 panel.

**Table A-1: Compatible Components (Manufactured by Silent Knight)**

Model	What it Does
2608 Ground Start Relay	Used for ground start phone lines(not UL listed).
4180 Status Display Module	For remote annunciation of alarm and trouble status information for each zone.
5220 Direct Connect Module	For direct alarming and trouble transmission from the 5204 to a supervising station.
5230 Remote Annunciator	Provides complete system control. Includes touchpad (keypad) with membrane keyswitches, back-lit LCD indication of zone and system status, and built-in speaker for audible annunciation. Used for programming with English-language prompts.
Quick connect program cable, part number 130294	For temporarily connecting the 5230 to the 5204 for programming.
5293 Distributed Power Module	For connecting more notification devices than the 5204 normally allows.
5541 Downloading Software	For remote programming of the 5204.
5530 Modem	Modem for downloading; required if using the 5541 software.
5205 Dialer Module	Enables the 5204 to function as a communicator panel.
7181 Zone Converter	Converts a zone from class B (style B) to class A (style D) or from class A to class B. One 7181 per zone to be converted.

---

## Section 2

# Specifications and System Planning

---

## 2.1 Electrical Specifications

---

Circuit	12-Volt Panel	24-Volt Panel
Primary AC	120 Vrms at 60 Hz, 2500 mA rms	120 Vrms at 60 Hz, 2500 mA rms
Total External DC Load	3.0A	3.0A
Accessory Power	9.5 V to 13.8 V max., 1500 mA	19.7 V to 27.6 V max., 1500 mA
+12 V Accessory Power	8.0 V to 14.0 V, 175 mA	11.5 V to 14.0 V, 175 mA
Bell Power	9.3 V to 13.8 V max., 1500 mA	19.8 V to 27.6 V max., 1500 mA
Smoke Power	9.3 V to 13.8V max., 1000 mA	19.7 V. to 27.6 V. max., 1000 mA
Battery Charging Voltage	13.5 to 13.8 V	27.0 V - 27.6 V
Minimum Low Battery Detect	10.2 V	20.4 V
Minimum Low AC Detect	100 Vrms at 60 Hz, full load	100 Vrms at 60 Hz, full load
Minimum Class B Trouble Detect	1.5 mA	2.4 mA
Maximum Class B Alarm Detect	11.7 mA	12.1 mA
Maximum Watchdog Response Time	50 sec.	50 sec.
<b>Note:</b> When running at full load, it is normal for the main heatsink to be hot.		

## 2.2 Environmental Specifications

---

It is important to protect the 5204 control panel from water. To prevent water damage, the following conditions should be AVOIDED when mounting the units:

- Do not mount directly on exterior walls, especially masonry walls (condensation)
- Do not mount directly on exterior walls below grade (condensation)
- Protect from plumbing leaks
- Protect from splash caused by sprinkler system inspection ports
- Do not mount in areas with humidity-generating equipment (such as dryers, production machinery)

When selecting a location to mount the 5204 control panel, the unit should be mounted where it will NOT be exposed to temperatures outside the range of 0° C-49° C (32° F-120° F) or humidity outside the range of 10%-85% at 30° C (86° F) noncondensing.

See also the mounting recommendations in Section 5.5.



## 2.3 Wiring Specifications

To avoid induced noise (transfer of electrical energy from one wire to another), keep input wiring isolated from high current output and power wiring. Induced noise can interfere with telephone communication or even cause false alarms. Avoid pulling one multiconductor cable for the entire panel. Instead, separate the wiring as follows:

<b>High current input/output:</b>	AC power, speaker, and notification device wiring
<b>Low current input/output:</b>	Annunciator and zone loop wiring
<b>Audio input/output:</b>	Telephone wiring

DO NOT pull wires from different groups through the same conduit. If you must run them together, do so for as short a distance as possible or use shielded cable. Connect the shield to circuit ground at the panel. You must route high and low voltages separately.

For the same reasons, you should route the wiring within the cabinet around the perimeter of the cabinet. It should not cross the printed circuit board where it could induce noise into the sensitive microelectronics or pick up unwanted RF noise from the high speed circuits.

High frequency noise, such as that produced by the inductive reactance of a speaker or bell, can also be reduced by running the wire through ferrite shield beads or by wrapping it around a ferrite toroid. See Figure 2-1.

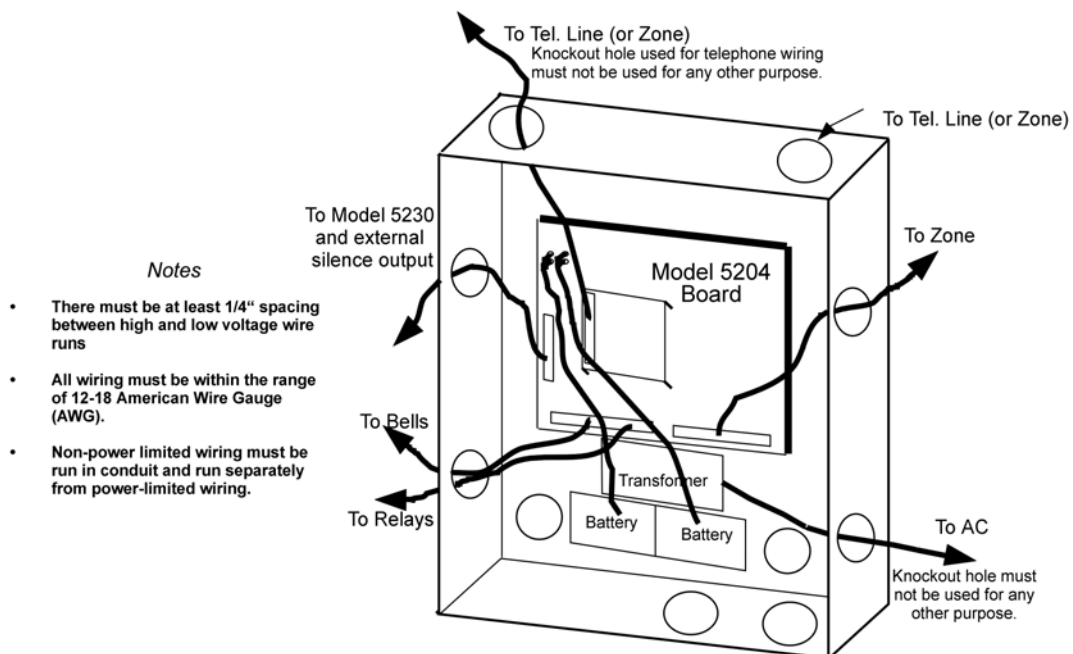

Figure 2-1 Wiring Identification

---

## Section 3

# Agency Listings, Approvals, and Requirements

---

### 3.1 Federal Communications Commission (FCC)

---

1. If requested by the telephone company, the following information must be provided before the 5204 can be connected to the phone lines:

A	Manufacturer:	Silent Knight Security Systems
B	Model Number:	5204
C	FCC registration number	AC6USA-73710-AL-E
	Ringer equivalence:	0.9B
D	Type of jack (to be installed by the telephone company)	RJ31X

2. This device may not be directly connected to coin telephone or party line services.
3. This device cannot be adjusted or repaired in the field. In case of trouble with the device, notify the installing company or return to:

Silent Knight Security Systems  
7550 Meridian Circle  
Maple Grove, MN 55369-4927  
612-493-6455  
800-328-0103

4. If the 5204 or 5205 dialer causes harm to the telephone network, the telephone company will notify the user in advance that temporary discontinuance of service may be required. If advance notice is not practical, the telephone company will notify the user as soon as possible. Users have the right to file complaints, if necessary, with the Federal Communications Commission.
5. The telephone company may make changes in its facilities, equipment, operations, or procedures that could affect the operation of the equipment. If this happens, the telephone company will provide advance notice to allow you to make the necessary modifications to maintain uninterrupted service.

#### 3.1.1 FCC Warning

**Warning**

This device has been verified to comply with FCC Rules Part 15. Operation is subject to the following conditions: (1) This device may not cause radio interference, and (2) This device must accept any interference received, including interference that may cause undesired operation.

## 3.2 Underwriters Laboratories (UL)

---

The 5204 is UL listed as a control unit for use in NFPA 72 systems. If the 5204 and its accessories are to be used as part of a UL installation, carefully read the UL requirements in this section. For more information on the following NFPA 72 standards, refer to the NFPA National Fire Alarm Code, 1993 Edition.

- Chapter 3  
Local Protected Fire Alarm Systems
- Chapter 4  
Central Station Fire Alarm Systems  
Auxiliary Protected Fire Alarm Systems for Fire Alarm Service (City Box)  
Remote Station Protected Fire Alarm Systems (Polarity Reversal)

### 3.2.1 Requirements for All Installations

General requirements are described below. When installing an individual device, refer to the specific section of the manual for additional requirements. See also the subsection below that describes special requirements for the type of installation (for example, Central Station Fire Alarm systems, Local Protected Fire Alarm systems, and so on).

1. All AC wiring to and from the 5204 cabinet must be enclosed in conduit.
2. Total 24-hour standby current must not exceed 875 mA in 12V mode or 438 mA in 24V mode. Total 60-hour standby current must not exceed 350 mA in 12V mode or 175 mA in 24V mode.
3. All electrical connections must comply with the ratings shown in Section 5.6.
4. Because the 5204 panel itself is the main source of alarm and trouble annunciation, you must select a location for the panel that allows alarms and troubles, including pre-alarms, to be heard by end-users responsible for maintaining the panel.

### 3.2.2 Requirements for Central Station Fire Alarm Systems

1. You must program a phone number and a test time (See Section 8, Step 69 and Step 76) so that the 5204 sends an automatic daily test to the central station.
2. In systems using class A (style D) zones (converted using the Model 7181 Zone Converter), do not use more than 5 waterflow devices. (See Section 6.2.5.)
3. Auxiliary relays may NOT be programmed to activate for Pre-Alarm. (See Section 8, Step 20.)

### **3.2.3 Requirements for Local Protected Fire Alarm Systems**

At least one UL listed supervised audible appliance must be used.

### **3.2.4 Requirements for Auxiliary Protected Fire Alarm Systems for Fire Alarm Service**

1. Do not exceed the current load restrictions shown in Section 4.
2. The Model 5220 Direct Connect module must be installed (see Section 6.2.2 for wiring).

### **3.2.5 Requirements for Remote Station Protected Fire Alarm Systems - Polarity Reversal**

1. Do not exceed the current load restrictions shown in Section 4.
2. The Model 5220 Direct Connect module must be installed (see Section 6.2.2 for wiring).

### **3.3 California Fire Marshal (CFM)**

---

The CFM approval number for the 5204 is 7165-0559:117

### **3.4 Factory Mutual (FM)**

---

The 5204 is FM approved under project # OW6A3.AY when used in conjunction with the Silent Knight Model 9000 Receiver.

### **3.5 Materials & Equipment Board of Acceptance (MEA)**

---

The 5204 is now approved under MEA. Previously, approval was given from the City of New York Board of Standards and Appeals (BSA). The 5204 is now approved under MEA Number 429-92-E.

# Section 4

## Installation Overview

### 4.1 Model 5204 Wiring Diagram

Figure 4-1 is a wiring diagram for wiring the various components of the Model 5204 panel. Any device connected to terminal 24 must be UL listed for fire use, and must be rated at 12 V/24 V. Terminals 22 and 26 are the only terminals that should be used to return smoke power and should not be used for any other purpose.

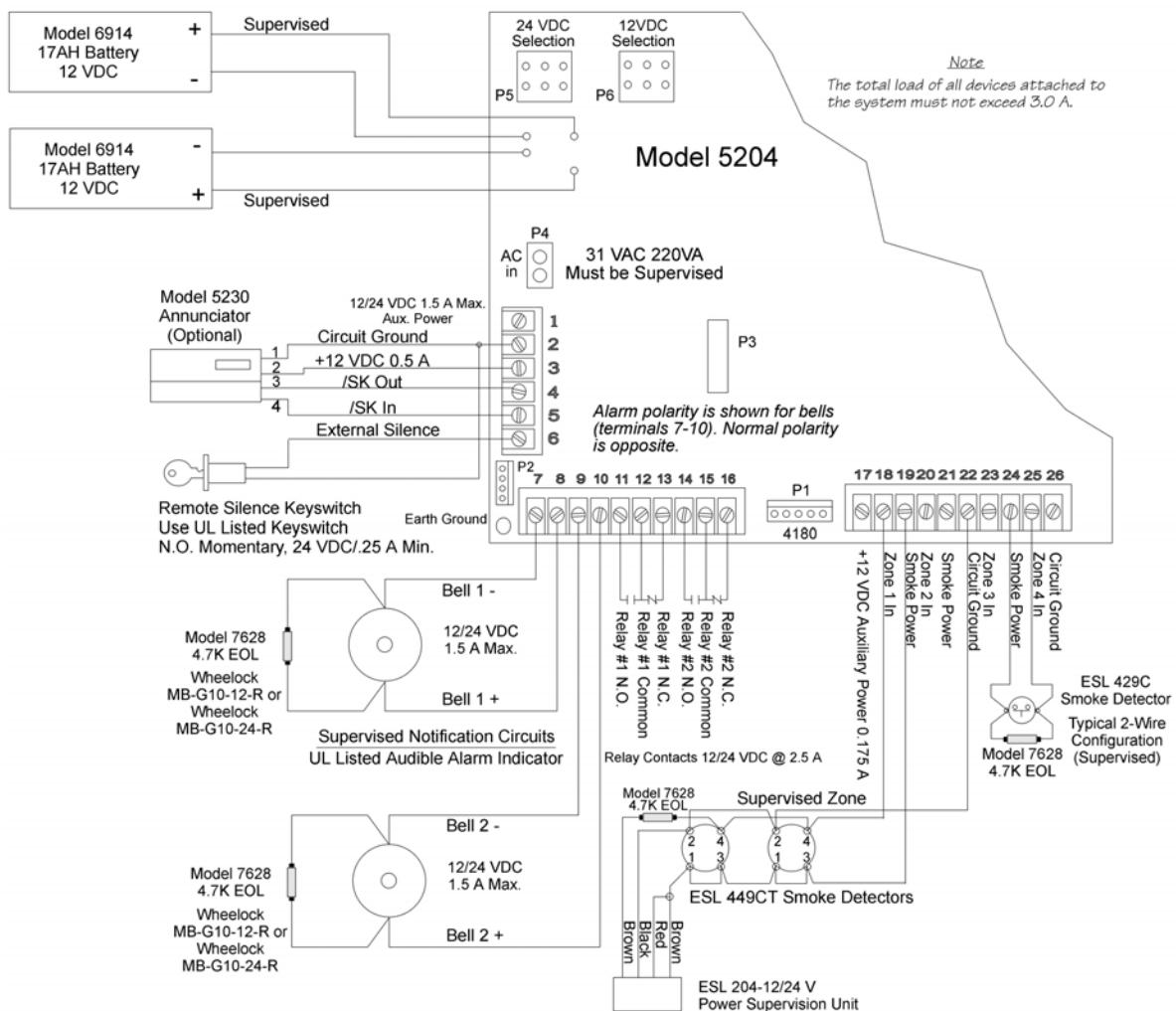

Figure 4-1 Model 5204 Wiring Diagram

## 4.2 Current Draw Worksheet

Device	Number of Devices	Current per Device	Standby Current	Alarm Current
For each device, use this formula: This column X This column = Current per number of devices				
5204 Fire Control/ Communicator	1	Standby: 120 mA	mA	
		Alarm: 400 mA		mA
4180 Status Display module	(2 max.)	Standby: 20 mA	mA	
		Alarm: 140 mA		mA
5205 Dialer	1	Standby : 10 mA	mA	
		Alarm: 100 mA		mA
5220 Direct Connect module	1	Standby: 50 mA	mA	
		Alarm: 50 mA		mA
5230 Remote Annunciator	(3 max.)	Standby: 60 mA	mA	
		Alarm: 120 mA		mA
7181 Zone Converter	(4 max.)	Standby 12V/24V: 52/35 mA	mA	
		Alarm 12V/24V: 90/65 mA		mA
<b>Current Subtotals:</b>			mA	mA
<b>Smoke Detectors</b>	Refer to device manual for current ratings. See Tables 6-2 and 6-3 for max. # per loop.			
		Standby: mA	mA	
		Alarm: mA		mA
		Standby: mA	mA	
		Alarm: mA		mA
		Standby: mA	mA	
		Alarm: mA		mA
<b>Current Subtotals:</b>			mA	mA
<b>Notification Devices</b>	Refer to device manual for number of devices and current ratings.			
		Alarm: mA		mA
		Alarm: mA		mA
<b>Current Subtotals:</b>			mA	mA
<b>Additional Devices</b>				
		Standby: mA	mA	
		Alarm: mA		mA
		Standby: mA	mA	
		Alarm: mA		mA
		Standby: mA	mA	
		Alarm: mA		mA
		Standby: mA	mA	
		Alarm: mA		mA
<b>Current Subtotals:</b>			mA	mA
Total current ratings of all devices in system (add A through D)*:			mA	mA
Total current ratings converted to amperes (x .001):			A	A

\* This information must be used with Table 4-1 and Table 4-2 to complete battery calculations.

## 4.2.1 Worksheet Example

A worksheet is included to help you calculate the amount of current the system draws on standby (idle) and in active (trouble or alarm) conditions. Refer to Table 4-2 to see the different battery sizes available and the maximum standby current load each can support.

Figure 4-2 illustrates how to complete the worksheet:

1 Cross out entire row of any devices not used. Note: Do not write in shaded areas.

2 In the blank spaces, write in any devices not printed on the worksheet (smoke detectors, notification devices, etc.).

3 The maximum number is shown in parentheses. The number "1" printed in this column indicates that only one device can be used.

4 Fill in missing current ratings for the devices used. Note that some devices have different ratings for standby and alarm conditions.

5 For devices with different standby and alarm currents, be sure to do the calculation for each rating.

6 For row E, add the subtotals from rows A-D and multiply by .001.

Device	Number of Devices	Current per Device	Standby Current	Alarm Current
<i>For each device, use this formula: This column X This column = Current per number of devices</i>				
5204 Fire Control /Communicator	1	Standby: 120 mA Alarm: 400mA	120 mA	400mA
<del>4180 Status Display module</del>	<del>(2 max.)</del>	<del>Standby: 20 mA Alarm: 140 mA</del>	<del>mA</del>	<del>mA</del>
5205 Dialer	1	Standby: 10 mA Alarm: 100 mA	10 mA	100mA
5220 Direct Connect module	1	Standby: 50 mA Alarm: 50 mA	50 mA	50 mA
5230 Remote Annunciator	3 (3 max.)	Standby: 60 mA Alarm: 120 mA	180 mA	360 mA
7181 Zone Converter	(4 max.)	Standby 12V/24V: 52/35 mA Alarm 12V/24V: 90/65 mA	mA	mA
<b>Current Subtotals:</b>			<b>360 mA</b>	<b>910mA</b>
<b>Smoke Detectors</b> <i>Refer to device manual for current ratings. See Tables 6-2 and 6-3 for max. # per loop</i>				
Model XYZ	2	Standby: .05 mA Alarm: 16 mA	.1 mA	32 mA
ESL 449CT	1	Standby: .07 mA Alarm: 15 mA	.07 mA	15 mA
		Standby: mA Alarm: mA	mA	mA
<b>Current Subtotals:</b>			<b>.17 mA</b>	<b>47 mA</b>
<b>Notification Devices</b> (4 max.) <i>Refer to device manual for current ratings.</i>				
		Alarm: mA		mA
<b>Total current ratings of all devices in system (add A-D)*:</b>			<b>360.17 mA</b>	<b>957 mA</b>
<b>Total current ratings converted to amperes (x .001):</b>			<b>0.360 A</b>	<b>0.957 A</b>

Figure 4-2 Current Draw Worksheet Example

Maximum current draw for signaling devices - 1.5 A

(See Section 6.3 for additional information on signaling outputs.)

Maximum Loop resistance for smoke detectors - 30 ohms

To measure maximum loop resistance, connect an ohmmeter across the leads of a disconnected loop.

(See Table 6-2 and Table 6-3 for maximum number of smoke detectors per loop.)



## 4.2.2 Worksheet Requirements

The following steps must be taken when determining 5204 current ratings:

1. For the Model 5204, you must measure the alarm (active) current. If only one current rating is listed, the draw for that device is the same whether the system is in alarm or standby condition. The exception is for notification devices, which are rated at alarm current only. Standby current for sounding devices is 0 mA.
2. To measure the maximum alarm current of the panel, measure the current draw (with no devices connected to the panel) by connecting a DC amp meter in series with one of the batteries. Disconnect the AC power source. Put the panel in alarm. The meter will indicate the alarm current, which will be in the range of 120-400 mA. Fill in the system alarm current in the Current per Device column on the Current Draw worksheet. You can estimate without measuring the alarm current by filling in the maximum total alarm current of 400 mA.

*Note: In a 12-volt system, measure the current from both batteries (disconnect both grounds).*

3. For smoke detectors, notification devices and devices not mentioned in the manual, refer to the device manual for the current ratings. The worksheet example shown on the previous page provides rough estimates for a “worst case” installation.
4. Use Table 4-1 to determine the battery amp hour rating needed for your installation. Refer to the example (Figure 4-3) that follows. Note that the calculated rating in Row H cannot exceed the ratings shown in Table 4-2).

**Table 4-1: Battery Calculations**

		Total Standby Current	Total Alarm Current
A	Total supervisory current from the Current Draw worksheet (row E).	A	
B	Number of standby hours (24 and 60 for NFPA 72, Chapter 1, 1-5.2.5).	H	
C	Multiply Lines A and B.	AH	
D	Total alarm current from the Current Draw worksheet (row E).		A
E	Alarm sounding period in hours. (For example, 5 minutes = .084 hours.)		H
F	Multiply lines D and E.		AH
G	Add lines C and F.	AH	
H	Multiply line G by 1.2. (Total ampere/hours required*)	AH	

\* Use next size battery with capacity greater than required.

This calculation is based on the Current Draw worksheet example data.  
From this table, the installer would use a 17 AH battery

		Total Standby Current	Total Alarm Current
A	Total supervisory current from the Current Draw worksheet (row E).	0.360 A	
B	Number of standby hours (24 and 60 for NFPA 72, Chapter 1, 1-5.2.5.).	24 H	
C	Multiply lines A and B.	8.64 AH	
D	Total alarm current from the Current Draw worksheet (row E).		0.957 A
E	Alarm sounding period in hours. (For example, 5 minutes = .084 hours.)		.084 H
F	Multiply lines D and E.		0.08AH
G	Add lines C and F.	8.72 AH	
H	Multiply line G by 1.2. (Total ampere/hours required*)	10.46 AH	

**Figure 4-3 Battery Calculation Example**

**Warning!**

Silent Knight does not support the use of batteries smaller than those listed in Table 4-2. If you use a battery too small for your installation, the system can overload it and you may have less than the required 24 hours standby power. Use Table 4-1 to calculate the correct battery amperes/hour rating needed for your installation.

- Refer to Table 4-2 to verify the battery size you need to provide at least the total standby current you have calculated. If the installation must meet requirements for NFPA 72 (Auxiliary Protected Fire Alarm Systems for Fire Alarm Service or Remote Station Protected Fire Alarm Systems - Polarity Reversal), the total standby current cannot exceed the amount shown in the last column of the following table:

**Table 4-2: Maximum Battery Standby Load**

Rechargeable Battery Size	Max. Load for 24 hrs. Standby, 5 mins. Alarm	*Max. Load for 60 hrs. Standby, 5 mins. Alarm
17 Amp Hours	438 mA	175 mA
34 AH (if wired in parallel)	875 mA	350 mA

\* Required for NFPA 72 Auxiliary Protected Fire Alarm systems for Fire Alarm Service (City Box) and Remote Station Protected Fire Alarm systems (Polarity Reversal).

The following formula was used to calculate the figures in Table 4-2:

$$I = [AH \div H] \times 0.70$$

Where: I = Standby current  
AH = Ampere-hour rating of battery  
H = Standby hours  
0.70 = A constant used to de-rate the battery to assure a 5-year life.

6. Ensure that the total alarm current you calculated, including current for the panel itself, does not exceed 3.5 A. This is the maximum alarm current allowable, whether the panel provides 12 V or 24 V of smoke power.

# Section 5

## Control Panel Installation

The major components of the Model 5204 PC board are described in this section. Figure 5-1 shows the 5204 (fuseless) printed circuit board.

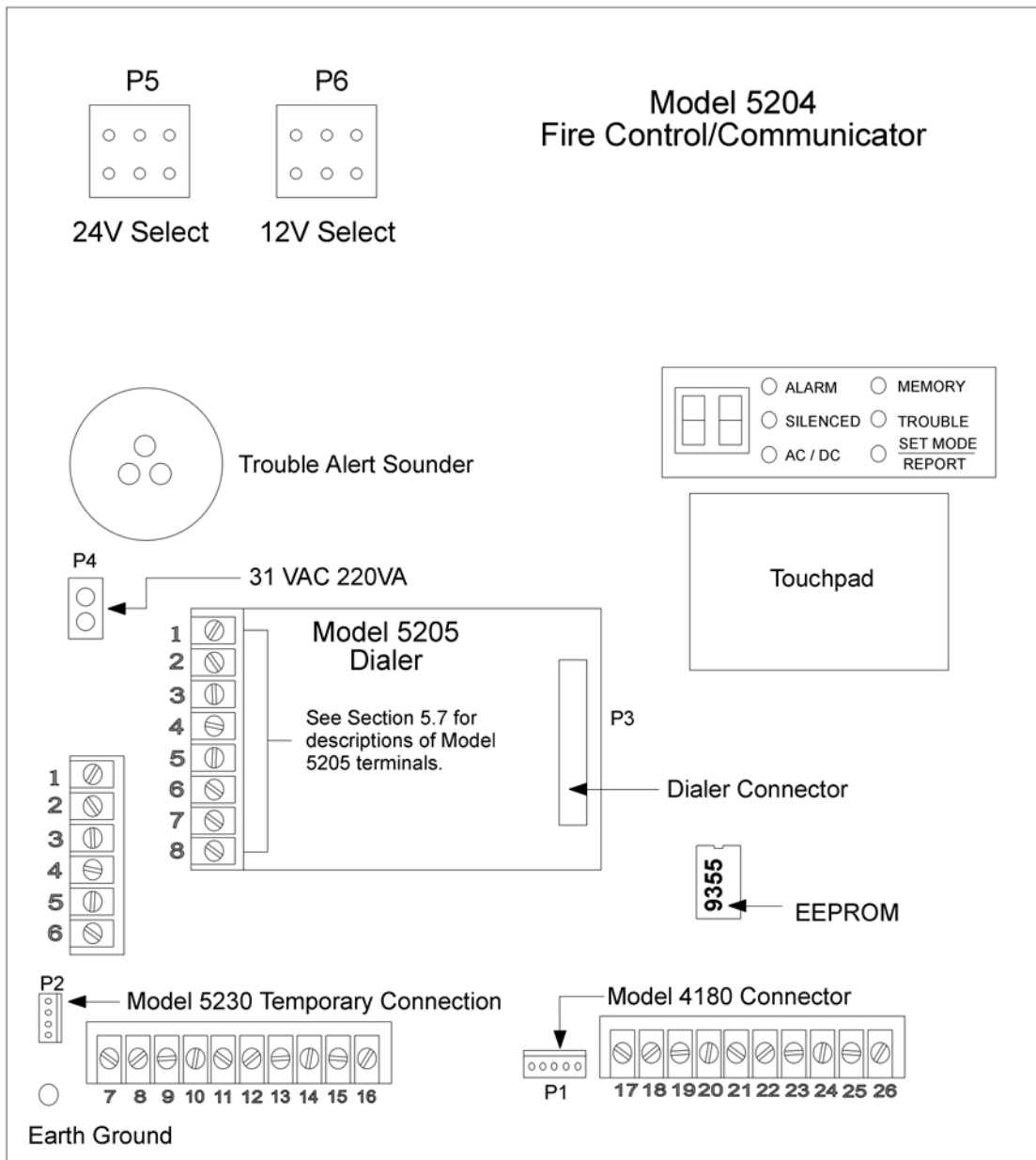

Figure 5-1 Model 5204 Board Assembly

### Caution

To avoid the risk of electrical shock, Do NOT apply power to the Model 5204 until told to do so in this manual (See Note in Section 6.2).

## 5.1 Grounding the Model 5204 Cover

---

Before connecting power to the 5204, connect the earth ground wire to the base and cover. Make sure that the ring lugs are oriented properly. The proper connection and orientation are shown in Figure 5-2. The star washers must be located between the ring lugs and the painted surfaces.

After attaching the cover and base, make a slight bend in the wire attached to the cover. This is to keep it from being caught between the cover and base when the cover is closed.

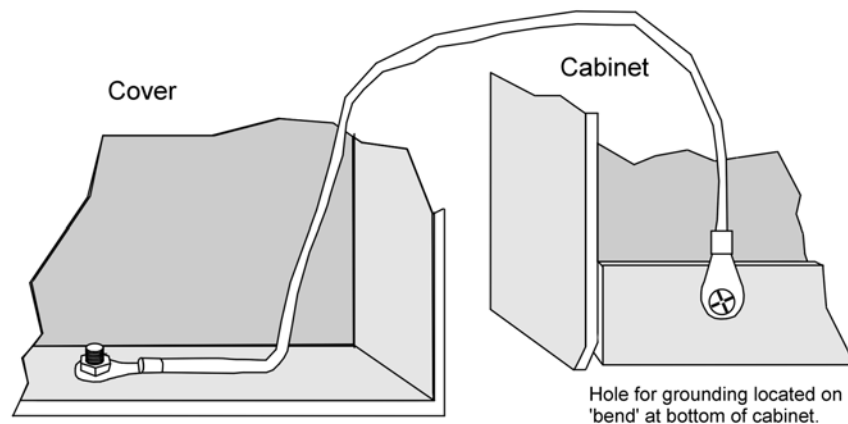

Figure 5-2 Connecting the Ground Wire

## 5.2 Smoke Power Selection

---

With AC power removed and batteries removed, insert the supplied jumper block (P/N 130412) into P5 for 24V or P6 for 12V.

## 5.3 Power Supply Wiring

---

A transformer is used to supply 31 VAC (220 VA) to power the system under normal conditions and to supply charging current to the backup batteries. The primary winding must be connected directly to the 120 VAC, 60 Hz power source (unswitched). Connect the secondary to the 5204 by plugging the cable into the AC connector on the circuit board.

*Note: It may be necessary for a professional electrician to connect the pigtail wires on the primary winding to the 120 VAC source.*

## 5.4 Battery Connection

---

*Note: When using two batteries, it is recommended that they be of the same ampere hour (AH) rating and approximately the same age.*

Battery cable connectors enable installation of one or two 12 VDC, 17 A rechargeable batteries. Two sets of battery leads are provided for battery connection. When connecting a single battery, connect one of the red leads to the positive side of the battery. Connect a black lead to the negative side of the battery.

If using a second battery, connect the remaining lead to the positive side of the second battery. Connect the remaining black lead to the negative side of the second battery.

## 5.5 Mounting the 5204

---

Read the environmental specifications in Section 2.2 before mounting the 5204 panel.

The panel should be accessible to “Main Drop” wiring runs. The 5204 panel should be mounted as close to the center of the building as possible and located within a secured area, but should be accessible for testing and service. End-users responsible for maintaining the panel should be able to hear alarms and troubles. When selecting a location, keep in mind that the panel itself is the main source of alarm and trouble annunciation.

Mount the 5204 so it is firmly secured to the wall surface. When mounting the 5204 on concrete, especially when moisture is expected, attach a piece of 3/4-inch plywood to the concrete surface and then attach the 5204 to the plywood. Also mount any other desired components (such as external printer) to the plywood. If you will be flush mounting the cabinet, the hole for the enclosure should be 14 1/2” x 19 1/8” (width x length of box only). Do NOT flush-mount in a wall designated as a fire break.

## 5.6 Terminal Strip Description

---

The terminal strips on the PC board are nonremovable. Table 5-1 below lists the function and electrical rating of each terminal. Note the following:

- The total load of all devices attached to the system must not exceed 3.0 A.
- Alarm polarity is shown for bells (terminals 7-10). Normal polarity is the opposite.
- Terminals 22 and 26 are the only terminals that should be used to return smoke power, and they should not be used for any other purpose.

**Important!**

The 5204 emits a hum that is not noticeable to most end users unless they are near the panel in a very quiet environment.

**Table 5-1: Terminal Strip Description**

Terminal Number	Terminal Description	Nominal VDC Output ("System Normal" Condition)	
		12 V Mode	24 V Mode
1*	Auxiliary Power (+) - 1500 mA max.	13.65	27.3
2*	Ground	0	0
3*	Annunciator Power (+) - 500 mA max.	13.5	13.6
4*	Serial Annunciator Data Out (SKO)	9.1	9.2
5*	Serial Annunciator Data In (SKI)	6.6	6.7
6*	External Silence Switch or Alarm Reset	8.6	8.6
7	Bell 1 - 1500 mA max.	5.0	10.0
8	Bell 1 +	0.95	1.9
9	Bell 2 - 1500 mA max.	5.0	10.0
10	Bell 2 +	0.95	1.9
11	Relay 1 Normally Open	N/A	N/A
12	Relay 1 Common	N/A	N/A
13	Relay 1 Normally Closed	N/A	N/A
14	Relay 2 Normally Open	N/A	N/A
15	Relay 2 Common	N/A	N/A
16	Relay 2 Normally Closed	N/A	N/A
17*	Auxiliary Power - 175 mA	13.64	13.77
18*	Zone 1 (Class B/Style B) Input	0.08	0.16
19*	Smoke Power	13.65	27.3
20*	Zone 2 (Class B/Style B) Input	0.08	0.16
21*	Smoke Power	13.65	27.3
22*	Ground	0	0
23*	Zone 3 (Class B/Style B) Input	0.08	0.16
24*	Smoke Power	13.65	27.3
25*	Zone 4 (Class B/Style B) Input	0.08	0.16
26*	Ground	0	0

\* Power-limited

Note: Combined smoke power maximum capacity is 1000 mA.

## 5.7 Model 5205 Dialer and Telephone Line Connection (Optional)

---

The Model 5205 Dialer Module enables the 5204 to function as a communicator panel and provides the following features:

- Optional two-number dialing with same or different account codes and reporting formats. Alarms, troubles, disables, and tests can be programmed to report to either or both numbers.
- Programmable as rotary-only or as rotary/Touch-Tone dialing.
- Ring Detect feature on line 1 for downloading data to panel from a remote computer site.
- Transient voltage protection of phone lines.
- Automatic daily test (programmable from Model 5230 annunciator, built-in touchpad, or remote site via downloading option).
- Optional ground start operation (not for use on UL systems).
- Compatibility with the following UL fire listed receivers:

Receiver	Formats it will Receive
Silent Knight Model 9000	All formats listed in Section 10
Osborn & Hoffman Quickalert	All formats listed in Section 10
Ademco 685	All tone burst formats (3/1 1400 Hz)
FBI CP220	3/1 and 4 + 2 formats
Radionics D6500	BFSK 1400/2300 formats

### Installation

To meet NFPA 72 Central Station Fire Alarm Systems requirements, both telephone lines must be installed.

Connect the 5205 to the phone line using an RJ31X type phone jack. The telephone company will install an RJ31X jack upon request.

The 5205 comes with stand-offs that you can place into the four holes just left of the built-in touchpad on the 5204 panel. To connect the 5205 to the 5204, make sure the dialer connector



pins are positioned correctly before pressing the 5205 onto the stand-offs.

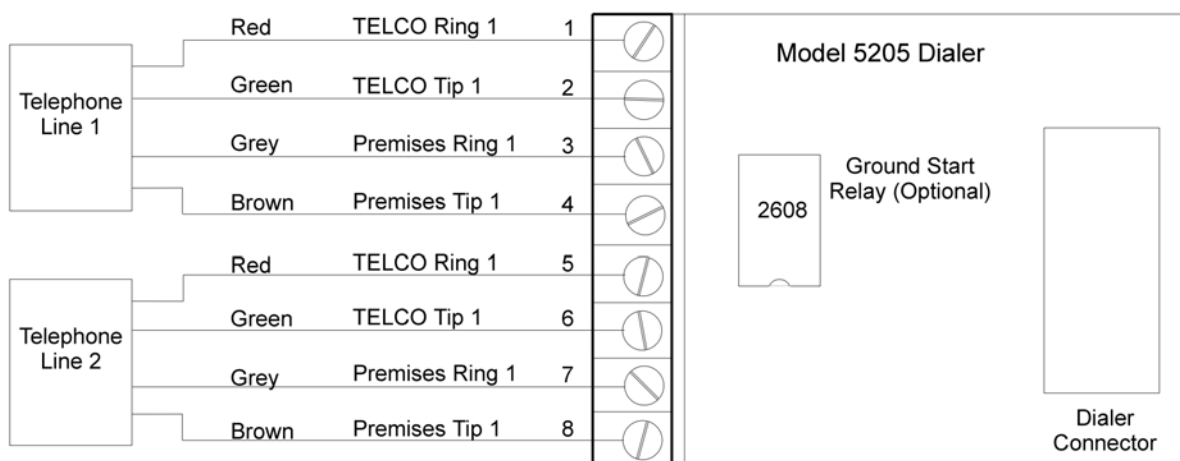

**Figure 5-3 Model 5205 Dialer/Telephone Connection**

### Ring Detect Circuit

If the installing company calls the 5204 to up- or download data to or from a remote computer, the built-in ring detect circuit on line 2 will detect the ring. After the programmed number of rings (Step 55 in Section 8), it seizes the line and allows the transfer of data.

The 5204 has built-in dual phone line monitors. These circuits will detect any fault in the phone lines by monitoring the DC voltage present on the lines. They feature a delay of approximately 40-90 seconds before a line fault is reported as a trouble. When a fault is detected, the audible trouble signal will sound and the trouble will be reported to the central station over the remaining phone line.

A situation could occur where both phone lines appear to be good, but the dialer cannot get through to the central station on the first line. In this case, the 5204 will switch phone lines and attempt the call again using the second line.

*Note: To comply with industry standards, this product is equipped with line seizure. Any time the system's dialer needs to communicate with the central station, it will not be possible to use any telephones that are on the same line(s) as the fire system. Normally, this condition will last approximately one minute, but under adverse telephone circuit conditions, could last for as long as 15 minutes.*

## 5.8 Cable Connectors

---

### Status (P1)

Connects the Model 4180 display model to the 5204.

### Model 5230 (P2)

Can be used to *temporarily* connect the Model 5230 Remote Annunciator to the 5204 for programming or troubleshooting.

*Note: A quick connect program cable (P/N 130294) can be ordered separately for this connection.*

### **Warning!**

Do NOT use connector P2 for permanent installation. If the annunciator is to be installed permanently, it MUST be wired to the 5204 terminal block (see Section Wiring the 5230 Remote Annunciator).

### Power Supply (AC) Connector (P4)

Connects the 5204 control panel to the power supply.



# Section 6

## Compatible Product Installation

### 6.1 Zone Wiring

This manual refers to fire zone types using the latest NFPA standard designations. If you have questions about the class or style, refer to the *NFPA 72 National Fire Alarm Code, 1993 Edition*.

*Note: For purposes of this manual, a normally open device is one with contacts that conduct when in the alarm condition and do not conduct in the non-alarm condition.*

The 5204 features four fully supervised, class B (style B) fire zones (also known as loops). All four zones have ground-fault detection and are protected against transient voltages.

Each zone consists of a two-wire circuit that detects the occurrence of an open in the loop, but may not be able to detect an alarm after such an occurrence. A short across the EOL resistor of the loop will cause an alarm to sound and the 5204 will report the trouble to the central station (if programmed to do so). An open or short to ground is a trouble condition. Use only normally open initiating devices for class B (style B) fire zones.

Zones 17 through 26 are class B (style B) fire zones. Figure 6-1 shows how to wire a class B loop. One side of each class B loop will connect to a zone input terminal and the other side of each loop will connect to smoke power. At the end of each class B (style B) loop, you must install a Model 7628 4.7K-ohm EOL resistor.

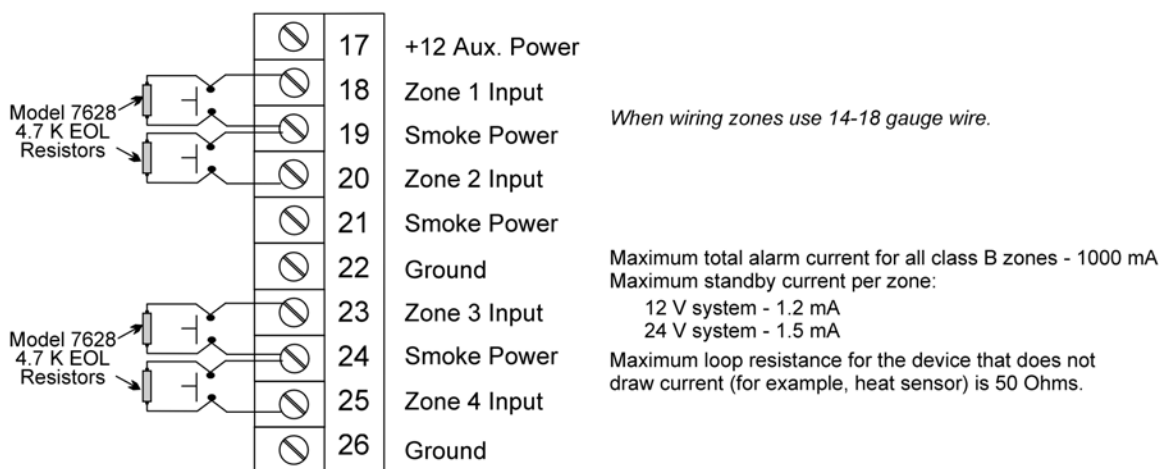

**Figure 6-1 Model 5204 Class B (style B) Loops (Normally Open Sensors Only)**

## 6.1.1 Four-Wire Smoke Detector Connection

Figure 6-2 illustrates how a UL listed four-wire smoke detector must be connected to a class B (style B) zone.

When wiring a four-wire smoke detector to class B (style B) zones, you must use a power supervision unit. The recommended device is an ESL 204 -12/24 V. The 7628 EOL resistor and the ESL 204 must be installed at the last detector in the loop.

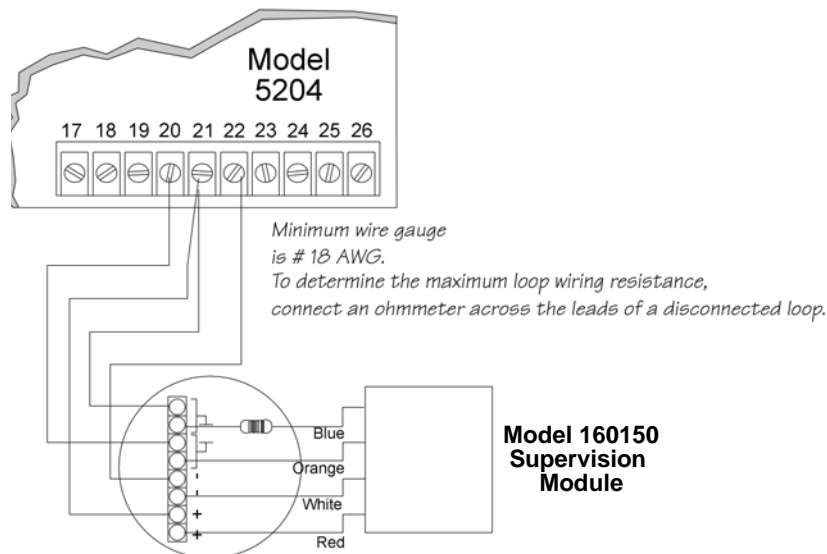

Figure 6-2 Four-Wire Smoke Detector Wiring

Table 6-1 shows other four-wire smoke detectors that can be used with the 5204 panel:

Table 6-1: Compatible Four-Wire Smoke Detectors

Manufacturer	Model Name/Number	12 or 24 Volt Panel
Detection Systems	DS200/DS200HD	Both
	MB200	Both
ESL	445 Series	Both
	449 Series	Both
GENTEX	624	24
	812	12
	824	24
	2040-12 Power Supervision Unit	12
	2040-24 Power Supervision Unit24	24
System Sensor	1851B	Both
	2851/2851BTH	Both
	DH400ACDC	24 or AC

## 6.1.2 Two-Wire Smoke Detector Connection

Figure 6-3 shows how to connect two-wire smoke detectors to class B (style B) zones.

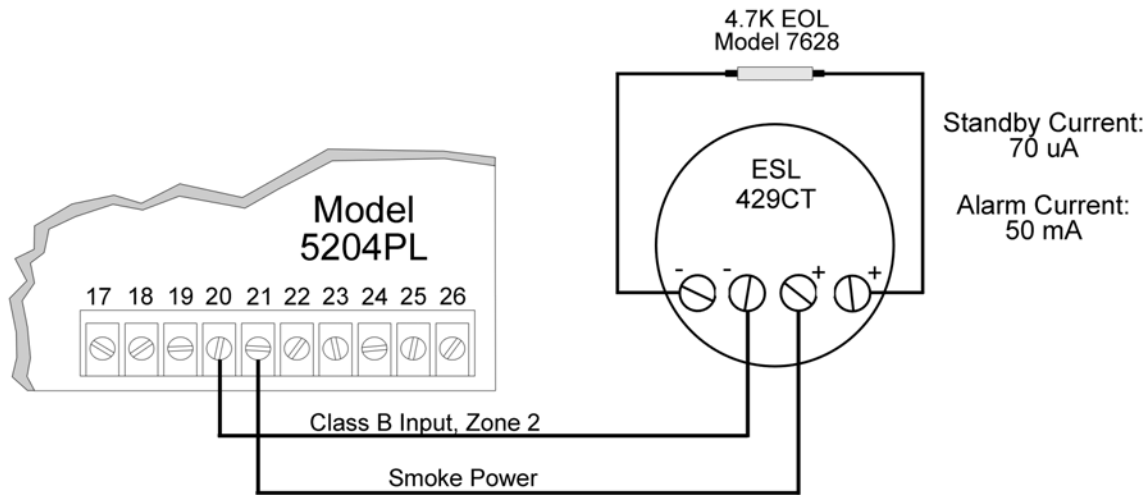

**Figure 6-3 Two-Wire Smoke Detector Wiring**

Table 6-1 and show the two-wire smoke detectors that are approved for use with the 5204.

### Notes for Both Tables

1. If a separate base is used with a detector, the model number is shown in parentheses in the Model column.
2. In the Type column, I = Ionization, P = Photoelectric, D = Duct
3. ID = Detector (Base) Identifiers
4. Control unit Smoke Reset Time must be programmed for a number greater than or equal to the maximum reset time of the smoke detector (last column of chart).
5. The maximum number of smoke detectors per zone is determined by both the current draw and the impedance of the smoke detector. If too many smoke detectors are used on any zone, false alarms could occur.
6. If different models of detectors are mixed on a zone, false alarms could occur.

Note: The 5204 contains a programmable smoke reset time. Be sure to program the panel to meet the reset time of the detectors.

**Table 6-2: Compatible 12-Volt Smoke Detectors**

Voltage range: 9.5 VDC - 14 VDC; Identifier: 12C

Manuf.	Model	Type	*ID	5204 (Max. per Loop)	Smoke Det.Reset Time
Detection Systems	DS200 (MB200-2W)	P	D	15	1 sec.
	DS200HD (MB200-2W)	P	D	15	1 sec.
	DS250 (MB2W or MB2WL)	P	B (A)	11	1 sec.
	DS250TH (MB2W or MB2WL)	P	B (A)	11	1 sec.
	DS250HD (MB2W or MB2WL)	P	B (A)	11	1 sec.
ESL	425C	P	S10	20	1 sec.
	425CT	P	S10	20	1 sec.
	425CR	P	S10	20	1 sec.
	425CRT	P	S10	20	1 sec.
	429C (S10A)	P	S10A	12	1 sec.
	429CT (S10A)	P	S10A	12	1 sec.
	429CRT (S11A)	P	S11A	12	1 sec.
	429CST (S11A)	P	S11A	12	1 sec.
	611U (601U)	P	S10 (S00)	24	1 sec.
	611UD (601U)	D	S10 (S00)	24	1 sec.
	611UT (610U)	P	S10 (S00)	24	1 sec.
	612U (601U)	I	S10 (S00)	24	1 sec.
	612U (601U)	D	S10 (S00)	24	1 sec.
	612UD (601U)	P	S10 (S03)	24	1 sec.
	611U (602U)	D	S10 (S03)	24	1 sec.
	611UD (602U)	P	S10 (S03)	24	1 sec.
	611UT (602U)	I	S10 (S03)	24	1 sec.
	612UD (602U)	D	S10 (S03)	24	1 sec.
System Sensor	1451 (B401B)	I	A	10	6 sec.
	1800	I	A	12	0.9 sec.
	1851B (B101B)	ID	A	10	2 sec.
	1851DH (DH1851DC)	ID	A	10	2 sec.
	2151 (B110LP)	P	A	10	.3 sec.
	2400	P	A	10	6 sec.
	2400 (DH400)	P	A	10	1 sec.
	2400TH	P	A	10	6 sec.
	2451 (B401B)	P	A	10	1 sec.
	2451TH (B401B)	P	A	10	6 sec.
	2800	P	A	10	6 sec.
	2800TH	P	A	10	6 sec.
	2851B (B101B)	PD	A	10	2 sec.
	2851TH (B101B)	PD	A	10	2 sec.
	2851DH (DH2851DC)I	PD	A	10	2 sec.

Note: Note: The 5204 contains a programmable smoke reset time. Be sure to program the panel to meet the reset time of the detectors.

**Table 6-3: Compatible 24-Volt Smoke Detectors**

Voltage range: 9.5 VDC - 14 VDC; Identifier: 12C

Manuf.	Model	Type	*ID	5204 (Max. per Loop)	Smoke Det. Rest Time
Apollo	55000-250 (45681-200)	I	55000-250 (45681-200)	24	1 sec.
	55000-350 (45681-200)	P	55000-350 (45681-200)	12	1 sec.
System Sensor	1451 (B401B)	I	A	12	6 sec.
	1800	I	A	12	0.9 sec.
	1851B (B101B)	ID	A	12	2 sec.
	1851DH (DH1851DC)	ID	A	12	2 sec.
	2151 (B110LP)	P	A	12	.3 sec.
	2400	P	A	12	6 sec.
	2400 (DH400)	P	A	12	1 sec.
	2400TH	P	A	12	6 sec.
	2451 (B401B)	P	A	12	1 sec.
	2451TH (B401B)	P	A	12	6 sec.
	2800	P	A	12	6 sec.
	2800TH	P	A	12	6 sec.
	2851B (B101B)	PD	A	12	2 sec.
	2851TH (B101B)	PD	A	12	2 sec.
	2851DH (DH2851DC)I	PD	A	12	2 sec.
Detection Systems	DS200 (MB200-2W)	P	D	24	1 sec.
	DS200HD (MB200-2W)	P	D	24	1 sec.
ESL	425	P	S10	30	1 sec.
	425CT	P	S10	30	1 sec.
	429C (S10A)	P	S10A	14	1 sec.
	429CT (S10A)	P	S10A	14	1 sec.
	429CRT (S11A)	P	S11A	14	1 sec.
	429CST (S11A)	P	S11A	14	1 sec.
	611U (601U)	P	S10 (S00)	30	1 sec.
	611UD (601U)	D	S10 (S00)	30	1 sec.
	611UT (610U)	P	S10 (S00)	30	1 sec.
	612U (601U)	I	S10 (S00)	30	1 sec.
	612U (601U)	D	S10 (S00)	30	1 sec.
	612UD (601U)	D	S10 (S03)	30	1 sec.
	611UD (602U)	P	S10 (S03)	30	1 sec.
	611UT (602U)	I	S10 (S03)	30	1 sec.
	612UD (602U)	D	S10 (S03)	30	1 sec.
Gentex	224	P	-25-1	16	6 sec.
Hochiki	SLK-24F (HS-224D)	P	HD-3 (HB-5)	20	0.1 sec.
	SLK-24FH (HS-224D)	P	HD-3 (HB-5)	20	0.1 sec.



## 6.2 Connections to Compatible Silent Knight Products

---

This section describes the connections of the following Silent Knight products:

- Model 4180 Status Display Module (see Section 6.2.1)
- Model 5220 Direct Connect Module (see Section 6.2.2)
- Model 5230 Remote Annunciator (see Section 6.2.3)
- Model 5395 Distributed Power Module (see Section 6.2.4)
- Model 5205 Dialer Module (see Section 5.7)
- Model 7181 Zone Converter (see Section 6.2.5)

*Note: Once you have installed the 5204 and, if applicable, the 5230 and the 4180, test the basic system. Apply power, test the touchpad, then remove the power. Wire each auxiliary device with the power off. After you install each device, test it by re-applying the power. When you power up the 5204, the two dots on the built-in touchpad display will alternately flash on and off.*

*Note also that there is a 2-second power-up delay on the 5230.*

### 6.2.1 Model 4180 Status Display Module

The Model 4180 Status Display module provides remote annunciation of alarm and trouble status information for each zone.

The 4180 has 2 connectors, each of which has 8 outputs available for annunciation. These outputs are active high at +12 VDC. Each output can provide up to 100 mA of current, with a total limitation of 175 mA (when used with the 5204). The module has 4 normally open relays that are nondedicated, and therefore can be wired to be active with any of the outputs. The 4180 is not supervised. Table 6-4 shows the system status indicated by each LED.

Do not use the 4180 relays in a 12 V 5204 installation.

**Table 6-4: Model 4180 Connection**

Connector P2	System Status	Connector P3	System Status
1	Alarm 1	1	Line #1 Trouble
2	Alarm 2	2	Line #2 Trouble
3	Alarm 3	3	Bell #1 Trouble
4	Alarm 4	4	Bell #1 Trouble
5	Trouble 1	5	Battery Trouble
6	Trouble 2	6	AC Trouble
7	Trouble 3	7	Silence Trouble
8	Trouble 4	8	Dialer Trouble

The 4180 can be used to interface to long-range RF systems.

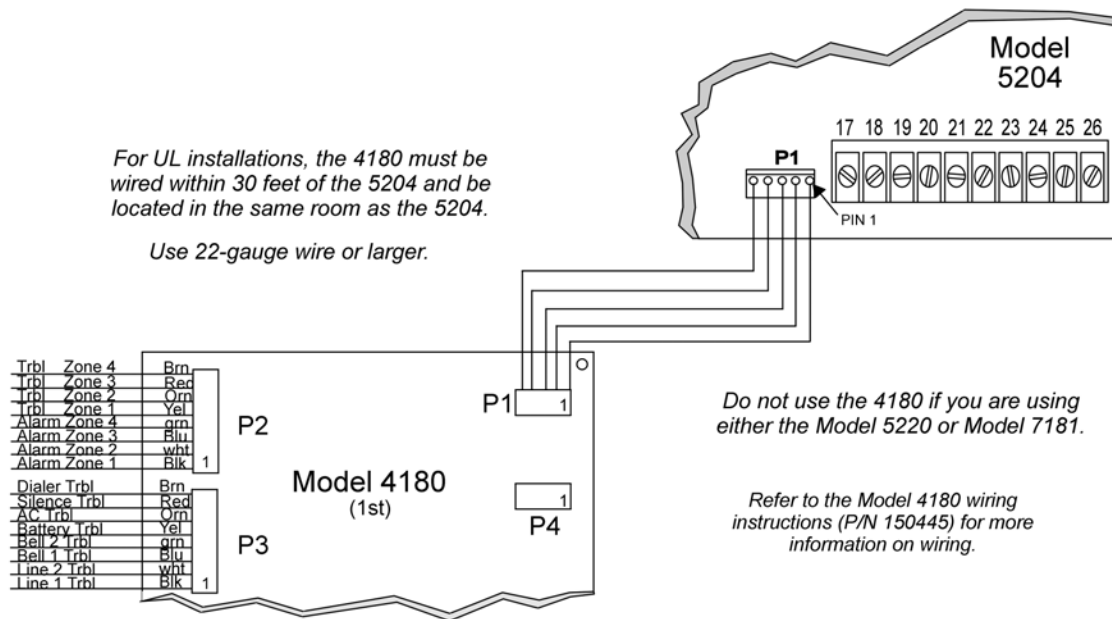

**Figure 6-4 Model 4180 Connection**

When using a 4180, maintain a physical separation of one-half inch or more between field wires and connection points to prevent damage from transients.

## 6.2.2 Model 5220 Direct Connect Module

The 5220 Direct Connect Module can be used with the 5204 to meet NFPA 72 Remote Signaling or Local Protective Signaling standards. The 5220 requires four connections to the 5204 and provides outputs for direct connect (city box) and polarity reversal.

To meet the 60-hour standby power requirements for NFPA 72 systems, normal standby currents are de-rated. See Section 4.2 for these current values.

### 6.2.2.1 Installation

Locate the knockout on the right side of the 5204 cabinet to connect the 5220 using a short piece of conduit (must not exceed 20 feet in length).

A four-wire pigtail is provided to wire the 5220 to the 5204. Figure 6-5 shows how to wire the Model 5220 Direct Connect module. The wiring chart uses bell #2 as the initiating loop. Program bell #2 to be active for the events to be reported.

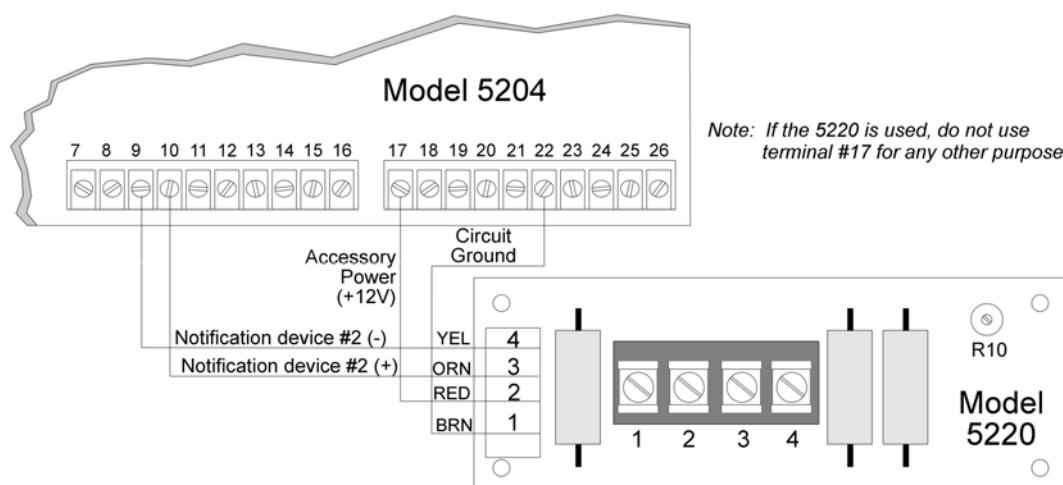

Figure 6-5 Model 5220 Wiring Diagram

### 6.2.2.2 City Box Connect (24 VDC Systems Only)

(For NFPA 72 Auxiliary Protected Fire Alarm systems for fire alarm service.)

With the 5220, you can connect the 5204 directly to a municipal fire alarm box or "city box." The city (master) box is an enclosure that contains a manually operated transmitter used to send an alarm to the municipal communication center, which houses the central operating part of the fire alarm system. To ensure communication of an active alarm status, use the 5220 only with 5204 24 V systems when connected to a series type DC master box.

Wire the 5220 to the 5204 as shown in Figure 6-5. Wire the city box coil to terminals 3 and 4 in the 5220. Maximum coil and wire resistance (combined) is 30 ohms.

It is not possible to reset the remote indication until you clear the condition and reset the 5204 panel.

Select relay 2 for 5220 city box. When you select 5220 operation, bell 2 and relay 2 cannot be used for any other purpose.

Any zone programmed to activate bell 2 will cause an alarm to be sent.

### 6.2.2.3 NFPA 72 Polarity Reversal (12 or 24 VDC Systems)

The 5220 provides a current that reverses polarity during an alarm or removes current during a trouble condition.

Wire the 5220 for polarity reversal as shown in Figure 6-6.

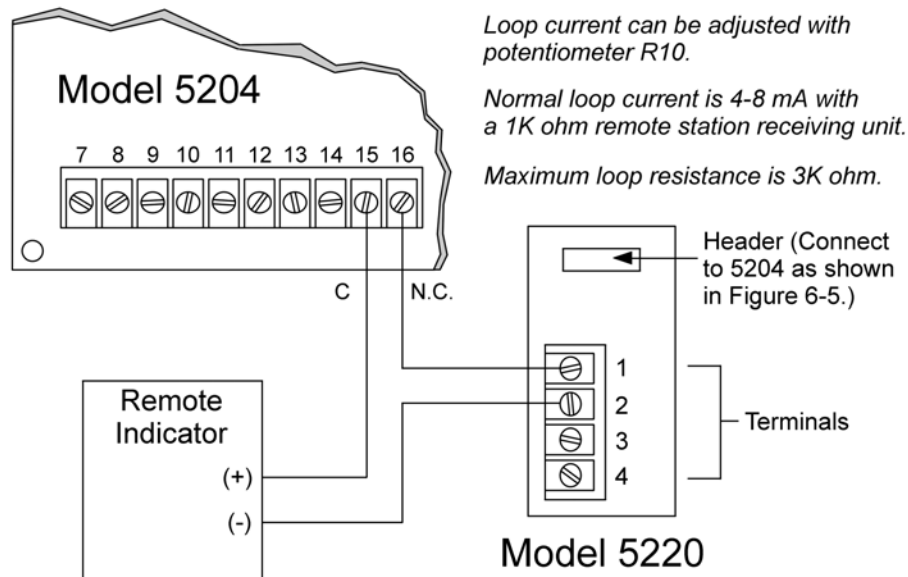

**Figure 6-6 Wiring the 5220 for Polarity Reversal**

Alarms will override trouble conditions, and it will not be possible to reset the remote indication until you clear the condition and reset the 5204 panel.

Select relay 2 for 5220 Direct Connect. When you select 5220 operation, bell 2 and relay 2 cannot be used for any other purpose.

Any trouble condition will cause a trouble to be sent. Any zone programmed to activate bell 2 will cause an alarm to be sent.

## 6.2.3 Model 5230 Remote Annunciator

The Model 5230 Remote Annunciator is an optional touchpad (keystation) you can use for English-language programming. The 5230 also provides trouble and alarm information.

When programming the 5204, be sure to select the correct number of supervised annunciators (see Section 8.4.3).

### 6.2.3.1 Setting ID Codes

Before permanently installing the Model 5230 Remote Annunciator, you must first set its identification codes. Each annunciator to be supervised must be given its own identification codes. The ID numbers must start at 1 and progress sequentially to 3 (3 annunciators max.). Upon initial power up, the address of each annunciator is displayed.

On the back of each annunciator is a small 4-position dip switch you can use to set the ID code. Table 6-5 shows the positions (up or down) of the various switches for specific ID codes.

**Table 6-5: Model 5230 Dip Switch Settings**

ID Number	Switches			
	1	2	3	4
0 *	Up	Up	Up	Up
1	Down	Up	Up	Up
2	Up	Down	Up	Up
3	Down	Down	Up	Up

\* Not Supervised

### 6.2.3.2 Wiring the 5230 Remote Annunciator

A 4-position terminal block is provided with the Model 5230 Annunciators to connect them to the 5204. Figure 6-7 shows the wiring for the Model 5230.

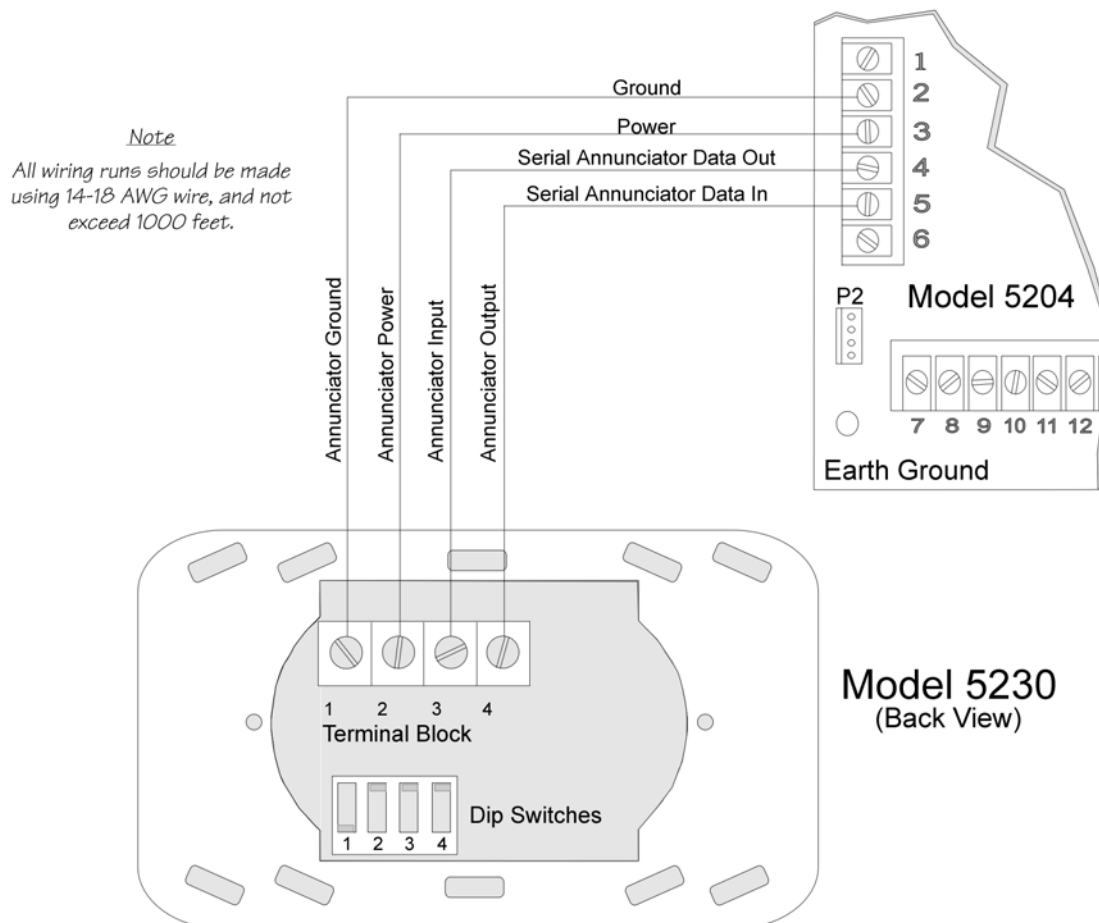

**Figure 6-7 Model 5230 Connection**

### 6.2.3.3 Mounting the 5230 Remote Annunciator

For UL installations, the 5230 Remote Annunciators must be mounted on a dual gang electrical box.

To mount the annunciator, you must first remove the rear mounting plate.

To do this, insert a #4 flat blade screwdriver into the slots located on the bottom edge of the annunciator. Gently turn the screwdriver until the mounting plate pulls away from the frame. Once you remove the mounting plate, you can secure it to the wall using #6 or #8 screws. The mounting plate should be oriented so that the word TOP is toward the top of the plate and facing you. Through the square hole in the mounting plate, run the wiring to the annunciator.

When all of the wires are connected to the annunciator, set the top of the annunciator over the tabs on the top of the mounting plate. Make sure the wires are not pinched between the frame and the mounting plate. Press each corner of the bottom side onto the annunciator mounting plate until you hear it click into place.

*Note: You may have to gently squeeze the annunciator (top to bottom) to align it while snapping the bottom edge into place.*

### 6.2.4 Model 5395 Distributed Power Module

Figure 6-8 shows you how to connect the Model 5395 to the Model 5204 panel.

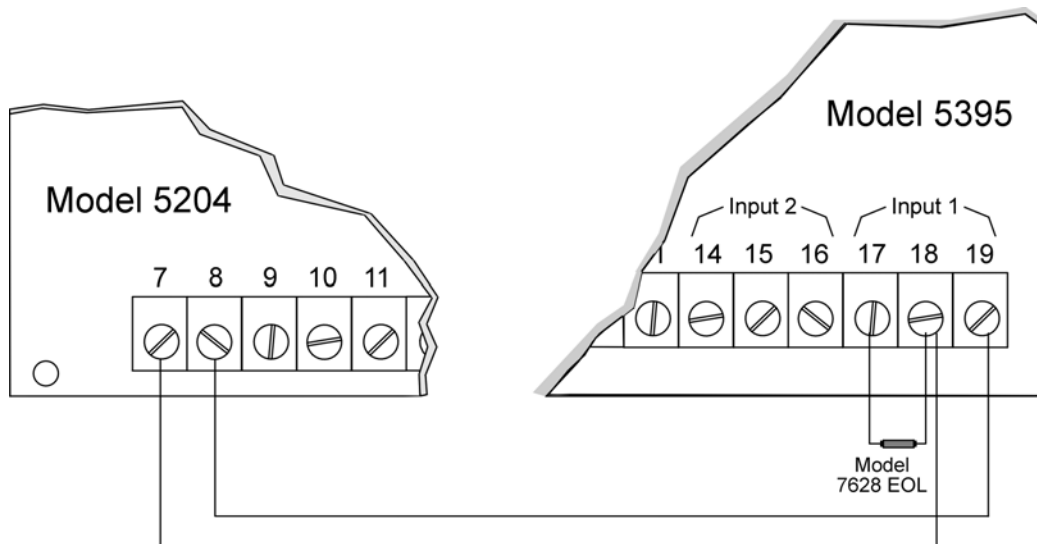

Figure 6-8 Model 5295 Connection

## 6.2.5 Model 7181 Zone Converter

The Model 7181 Zone Converter adapts the 5204 class B (style B) zones so that they can be connected to class A (style D) initiating devices. Figure 6-9 shows a typical installation. Refer to the Model 7181 Installation Manual (P/N 150632) for further information.

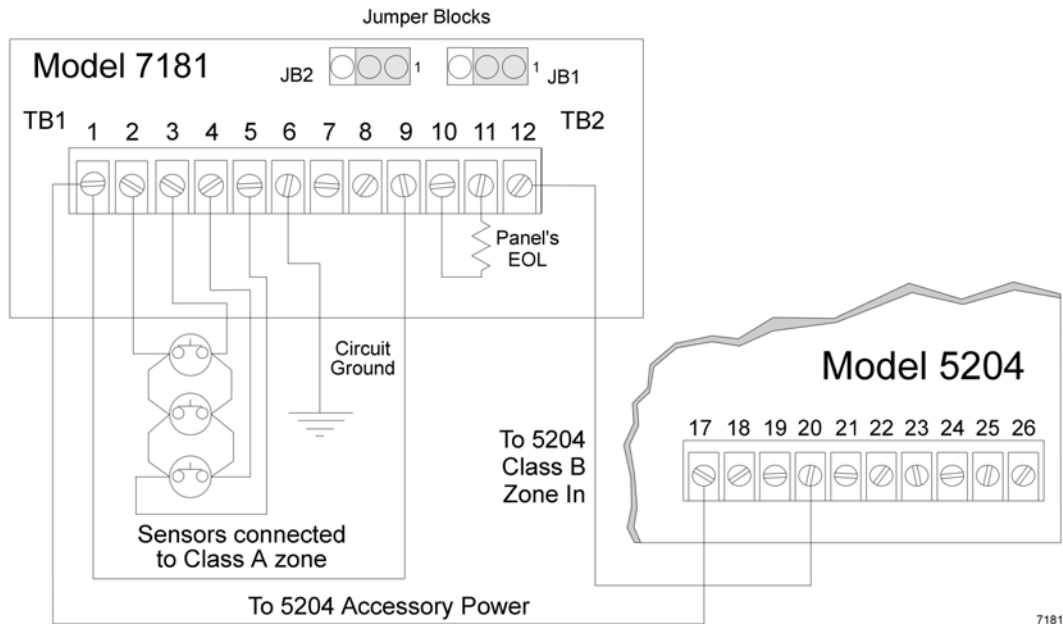

Figure 6-9 Connecting Class B (Style B) Sensor to Class A (Style D) Panel (24 V)

## 6.3 Supervised Notification Device Outputs

*Note: To reduce the possibility of false alarms and transient damage, DO NOT bundle telephone wires together with notification device or zone wires.*

The 5204 provides two supervised notification device outputs to annunciate alarm conditions. These outputs can be programmed for each individual zone. For proper operation, you must use polarized notification devices with a model 7628 4.7K ohm end-of-line (EOL) resistor on each loop. See Figure 6-10 for connection to the 5204 panel.

*All supervised notification devices used with the 5204 MUST be polarized.*



**Figure 6-10 Model 5204 Notification Device Connections**

The UL listed sounding appliances that can be used with the 5204 are listed in Table 6-6 and Table 6-7.

**Table 6-6: Compatible 12-Volt Notification Devices**

Manufacturer	Model Number	Device Type
Federal Signal	VALS	Strobe
	450-D	Horn
Gentex	HG124	Horn
	SHG12L	Horn Strobe
	SHG12H	Horn Strobe
Wheelock	34T-12-R	Alarm Horn
	462-G10-12-R	Bell
	700IT-12-R	Mini-Horn
	700IT-12-W	Mini-Horn
	700IT-12W-FR	Strobe Horn
	7002T-12-W-FR	Strobe Horn
	MB-G6-12-R	Motor Bell
	MB-G10-12-R	Motor Bell
	MBS-G6-12-W-HF-R	Motor Bell with Strobe
	MBS-G10-12-W-HF-R	Motor Bell with Strobe
	MIZ-12-R	Mini-Horn
	MIZ-12-W	Mini-Horn
	MIZ-12-WS-VF-R	Mini-Horn/Strobe
	MT-12/24-R	Strobe Horn
	V700IT-W-FR	Strobe Horn
	WST-12-FR	Strobe
	WSIT-12-FR	Strobe
WS3T-12-FR	Strobe	



**Table 6-7: Compatible 24-Volt Notification Devices**

Manufacturer	Model Number	Device Type
Faraday	446X 12/24VDC	Vibrating Bell
	476X 12/24VDC	Vibrating Bell
	477X 12/24VDC	Single Stroke Bell
	5303B-0-14-( )-DC	Chime (flush)
	5304B-0-14-( )-DC	Chime (surface)
	5305B-0-4-( )-DC	Chime (ceiling)
	5306B-0-14-( )-24-DC	Chime/Strobe (flush)
	5307B-0-14-( )-24-DC	Chime/Strobe (surface)
	5308B-0-4-( )-24-DC	Chime/Strobe (ceiling)
	5333B-0-14-24-DC	Multi-Tone Horn (flush)
	5334B-0-14-24-DC	Multi-Tone Horn (surface)
	5336B-( )-14-24-DC	Multi-Tone Horn/Strobe (flush)
	5337B-( )-14-24-DC	Multi-Tone Horn/Strobe (surface)
	5338B-( )-4-24-DC	Multi-Tone Horn/Strobe (ceiling)
	5343B-0-14-24-DC	Single Tone Horn/Strobe (flush)
	5344B-0-14-24-DC	Single Tone Horn/Strobe (surface)
	5345B-0-4-24-DC	Single Tone Horn/Strobe (ceiling)
	5348B-( )-4-24-DC	Single Tone Horn/Strobe (ceiling)
	5373B-0-14-(12 or 24)-DC	8-Tone Horn/Strobe (flush)
	5374B-0-14-(12 or 24)-DC	8-Tone Horn/Strobe (surface)
	5375B-0-4-(12 or 24)-DC	8-Tone Horn/Strobe (ceiling)
	5376B-0-14-24-DC	8-Tone Horn/Strobe (flush)
	5377B-0-14-24-DC	8-Tone Horn/Strobe (surface)
	5378B-0-4-24-DC	8-Tone Horn/Strobe (ceiling)
	5405B-0-14-24-DC	Sync Control Unit
	5508B-( )-14-24-DC	Single Gang Sync Strobe (flush)
	5521B-( )-14-24-DC	4" Square Sync Strobe (surface)
	5522B-( )-14-24-DC	4" Square Sync Strobe (flush)
	6126B-U-14-24 VDC	Horn/Strobe
	6223B-0-14-24-DC	Horn (flush)
	6224B-0-14-24-DC	Horn (surface)
	6225B-0-4-24-DC	Horn (ceiling)
	6226B-( )-14-24-DC	Horn/Strobe (flush)
	6227B-( )-14-24-DC	Horn/Strobe (surface)

Table 6-7: Compatible 24-Volt Notification Devices

Manufacturer	Model Number	Device Type
<b>Faraday (continued)</b>	6228B-( )-4-24-DC	Horn/Strobe (ceiling)
	6243B-0-14-24-DC	Electron-Mechanical Horn (flush)
	6244B-0-14-24-DC	Electron-Mechanical Horn (surface)
	6245B-0-4-24-DC	Electron-Mechanical Horn (ceiling)
	6246B-( )-14-24-DC	Electron-Mechanical Horn/Strobe (flush)
	6247B-( )-14-24-DC	Electron-Mechanical Horn/Strobe (surface)
	6248B-( )-4-24-DC	Electron-Mechanical Horn/Strobe (ceiling)
	6300B-0-14-24-DC	Mini-Horn (flush)
	6301B-0-14-24-DC	Mini-Horn (surface)
	6302B-( )-4-24-DC	Mini-Horn (ceiling)
	6310B-0-14-24-DC	Mini-Horn/Strobe/Strobe (flush)
	6311B-0-14-24-DC	Mini-Horn/Strobe/Strobe (surface)
	6312B-( )-14-24-DC	Mini-Horn/Strobe/Strobe (ceiling)
	6320B-0-14-24-DC	Sync Mini Horn/Strobe (1 gang)
	6321B-0-14-24-DC	Sync Mini Horn/Strobe (1,2 gang)
	6322B-( )-14-24-DC	Mini Horn/Sync Strobe (1,2 gang, 4SQ)
<b>Federal Signal</b>	450	Horn
	VALS	Horn/Strobe
<b>Gentex</b>	GX90-4	Horn
	GXS-4-15-1	Strobe
	GXS-4-1575	Strobe
	GX90S-4-15	Horn
	GX90S-4-1575	Horn
	HG124	Horn
	SHG24-1575	Horn/Strobe
	SHG24-15	Horn/Strobe
	GMH-24-X	Horn
	GMS-24-X	Horn/Strobe
	GMS-24-X	Horn/Strobe
	G0T24	Horn
	G0S24-X	Horn
	WGMS-24-X	Horn/Strobe

**Table 6-7: Compatible 24-Volt Notification Devices**

Manufacturer	Model Number	Device Type
<b>System Sensor</b>	MASS241	Horn/Strobe
	MASS24110ADA	Horn/Strobe
	MASS2415ADA	Horn/Strobe
	MASS2475ADA	Horn/Strobe
	SS1215ADA	Strobe
	SS4110ADA	Strobe
	SS2415ADA	Strobe
	SS2475ADA	Strobe
	PS2415ADA	Mini-Horn/Strobe
	PS241575ADA	Mini-Horn/Strobe
	PS24110ADA	Mini-Horn/Strobe
	PS2475ADA	Mini-Horn/Strobe
	<b>Wheelock</b>	46T-G4-24-R
46T-G6-24-R		Bell
46T-G10-24-R		Bell
46T-G6-24-WS-24-HF-R		Strobe/Bell
46T-G10-24-WS-24-HF-R		Strobe/Bell
46T-G6-24-WH-24-HF-R		Strobe/Bell
46T-G10-24-WH-24-HF-R		Strobe/Bell
700IT-12\24-W-FR		Strobe Horn
7002T-12\24-W-FR		Strobe Horn
AES-DL1-R		Multitone Horn
AES-EL1-R		Multitone Horn
AES-DL1-WS-24-VF-R		Multitone Horn
AES-EL1-WS-24-VF-R		Multitone Horn
AES-DL1-WH-24-VF-R		Multitone Horn
AES-EL1-WH-24-VF-R		Multitone Horn
AES-DL1-WM-24-VF-R		Multitone Horn
AES-EL1-WM-24-VF-R		Multitone Horn
AH-24-R		Horn
AMT-12\24-R		Strobe Horn
AMT-24-LS-VFR		Strobe Horn
AMT-24-LSM-VFR		Strobe Horn
AMT-24-IS-VFR		Strobe Horn
AS-2415-VFR		Strobe Horn
AS-241575-VFR		Strobe Horn

Table 6-7: Compatible 24-Volt Notification Devices

Manufacturer	Model Number	Device Type
Wheelock (cont.)	AS-2430-VFR	Strobe Horn
	AS-2475-VFR	Strobe Horn
	AS-24110-HFR	Strobe Horn
	SM-12\24-R	Strobe Horn Controller
	DSM-12\24-R	Strobe Horn Controller
	CF-BF1	Chime
	CF-BF1-R	Chime
	CH-CF1	Chime
	CH-CF1-R	Chime
	CH-CF1-W	Chime
	CH-DF1	Chime
	CH-DF1-R	Chime
	CH-BF1-WS-24-HF-R	Strobe Chime
	CH-CF1-LS-24	Strobe Chime
	CH-CF1-MS-24	Strobe Chime
	CH-CF1-IS-24	Strobe Chime
	CH-CF1-LS-24-CFW	Strobe Chime
	CH-CF1-MS-24-CFW	Strobe Chime
	CH-CF1-IS-24-CFW	Strobe Chime
	CH-CF1-WS-24-CF-W	Strobe Chime
	CH-DF1-LS-24	Strobe Chime
	CH-DF1-MS-24	Strobe Chime
	CH-DF1-IS-24	Strobe Chime
	CH-DF1-LS-24-VFR	Strobe Chime
	CH-DF1-LSM-24-VFR	Strobe Chime
	CH-DF1-MS-24-VFR	Strobe Chime
	CH-DF1-IS-24-VFR	Strobe Chime
	CH-DF1-WM-24-VFR	Strobe Chime
	CH-DF1-WS-24-VF-R	Strobe Chime
	DSM-12/24	Sync Module
	EH-DL1-R	Electronic Horn
	EH-EL1-R Electronic Horn	Electronic Horn
	EHS-DL1-W-VF-R	Strobe Horn (single input)
	EHS-EL1-W-VF-R	Strobe Horn (single input)
	EH-DL1-WS-24-VF-R	Strobe Horn (dual input)
	EH-EL1-WS-24-VF-R	Strobe Horn (dual input)

**Table 6-7: Compatible 24-Volt Notification Devices**

Manufacturer	Model Number	Device Type
<b>Wheelock (cont.)</b>	EH-DL1-WH-24-VF-R	Strobe Horn (dual input)
	EH-EL1-WH-24-VF-R	Strobe Horn (dual input)
	EH-DL1-WM-24-VF-R	Strobe Horn (dual input)
	EH-EL1-WM-24-VF-R	Strobe Horn (dual input)
	HSW-24-HFR	Remote Strobe
	HS2W-24-HFR	Remote Strobe
	HSPW-24-HFR	Remote Strobe
	IS-24-VFR	Remote Strobe
	IS1-24-VFR	Remote Strobe
	IS3-24-VFR	Remote Strobe
	ISP-24-HFR	Remote Strobe
	LS-24-VFR	Remote Strobe
	LS1-24-VFR	Remote Strobe
	LS3-24-VFR	Remote Strobe
	LSP-24-HFR	Remote Strobe
	LSM-24-VFR	Remote Strobe
	LS1M-24-VFR	Remote Strobe
	LS3M-24-VFR	Remote Strobe
	LSPM-24-VFR	Remote Strobe
	MS-24-VFR	Remote Strobe
	MS1-24-VFR	Remote Strobe
	MS3-24-VFR	Remote Strobe
	MSP-24-HFR	Remote Strobe
	MB-G6-24-R	Motor Bell
	MB-G10-24-R	Motor Bell
	MBS-G6-24-W-HF-R	Motor Bell with Strobe
	MBS-G10-24-W-HF-R	Motor Bell with Strobe
	MIZ-24-R	Mini-Horn
	MIZ-24-W	Mini-Horn
	MIZ-24-LS-VFR	Mini-Horn/Strobe
	MIZ-24-LSM-VFR	Mini-Horn/Strobe
	MIZ-24-MS-VFR	Mini-Horn/Strobe
	MIZ-24-HSW-HFR	Mini-Horn/Strobe
	MIZ-24-IS-VFR	Mini-Horn/Strobe
MIZ-24-WS-VF-R	Mini-Horn/Strobe	
MIZ-24-WS-VF-W	Mini-Horn/Strobe	

Table 6-7: Compatible 24-Volt Notification Devices

Manufacturer	Model Number	Device Type
Wheelock (cont.)	MIZ-24-WH-VF-W	Mini-Horn/Strobe
	MIZ-24-WM-VF-W	Mini-Horn/Strobe
	MT-12/24-R	Strobe Horn
	MT-24-LS-VFR	Strobe Horn
	MT-24-LSM-VFR	Strobe Horn
	MT-24-MS-VFR	Strobe Horn
	MT-24-IS-VFR	Strobe Horn
	MT-24-SL-VFR	Strobe Horn
	MT-24-SLM-VFR	Synch. Multitone Strobe
	MT-24-WM	Strobe
	MT-24-WM-VF-R	Horn
	MT-24-WM-VFR	Horn
	RS-2415-HFR	Strobe
	RSP-2415-VFR	Strobe
	RS-241575-VFR	Strobe
	RSP-241575-VFR	Strobe
	RS-2430-VFR	Strobe
	RS-2430-HFR	Strobe
	RS-2475-VFR	Strobe
	RSP-2475-HFR	Strobe
	RS-24110-HFR	Strobe
	RSP-24110-HFR	Strobe
	SL-24-VFR	Synchronized Remote Strobe
	SL1-24-VFR	Synchronized Remote Strobe
	SL3-24-VFR	Synchronized Remote Strobe
	SLP-24-VFR	Synchronized Remote Strobe
	SLM-24-VFR	Synchronized Remote Strobe
	SL1M-24-VFR	Synchronized Remote Strobe
	SL3M-24-VFR	Synchronized Remote Strobe
	SLPM-24-VFR	Synchronized Remote Strobe
	SHW-24-VFR	Synchronized Remote Strobe
	SH2W-24-VFR	Synchronized Remote Strobe
	SHPW-24-VFR	Synchronized Remote Strobe
	SCM-24-R	Controller for Synchronized Strobes
	SM-12/24-R	Sync Module
	SR-2415-VFR	Sync Strobe

**Table 6-7: Compatible 24-Volt Notification Devices**

Manufacturer	Model Number	Device Type
<b>Wheelock (cont.)</b>	SRP-2415-HFR	Sync Strobe
	SR-241575-VFR	Sync Strobe
	SRP-241575-VFR	Sync Strobe
	SR-2475-VFR	Sync Strobe
	SR-2475-HFR	Sync Strobe
	SR-24110-HFR	Sync Strobe
	SRP-24110-HFR	Sync Strobe
	V700IT-12\24-W-FR	Strobe Horn
	WM3T-24-FR	Remote Strobe
	WM3T-24-VFR	Remote Strobe
	WSIT-24-FR	Strobe
	WS3T-24-FR	Strobe
	WST-24-FR	Strobe

## 6.4 Auxiliary Relays

---

The 5204 provides two auxiliary relay outputs. Relay #2 output annunciates fire alarms. Relay #2 can be programmed to annunciate either alarm or trouble conditions, or can be used to activate the Model 5220 Direct Connect Module. Figure 6-11 shows the relay contact connections.)

- Fire alarm
- The Model 5220 Direct Connect Module (see Section 6.2.2).
- Trouble Conditions (any system trbl.)

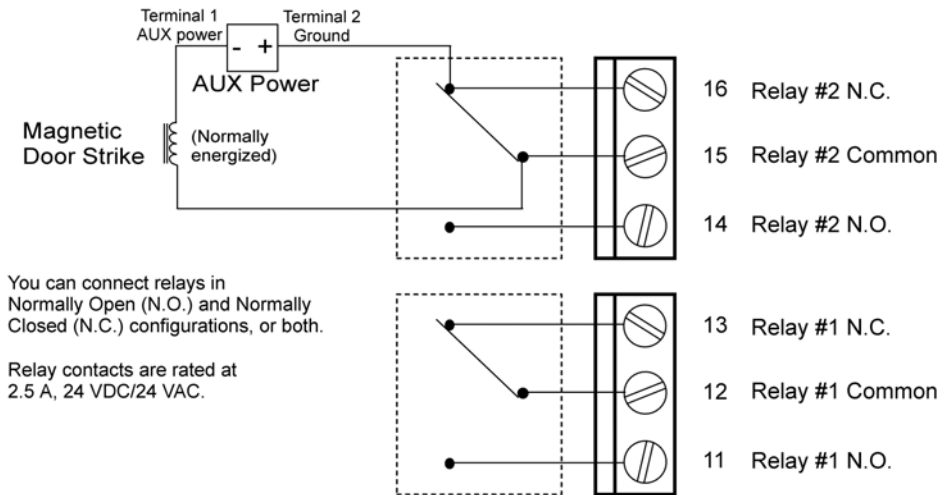

Figure 6-11 Auxiliary Relays

## 6.5 External Silence Keyswitch (Optional)

For manual silencing or resetting alarms, you can attach a remote keyswitch to the 5204 at terminal #6. Use a UL listed keyswitch. The keyswitch will operate as Normally Open Momentary at 24 VDC/.25 A minimum.

Once the keyswitch has been wired, it must be programmed either to silence or reset alarms (see Section 8.4.1.). If programmed to silence, the keyswitch turns off an annunciator that is signaling a trouble or alarm condition.

If programmed to reset alarms, the keyswitch removes smoke detector power for a programmed length of time (see Section 8.4.1). This allows the smoke detector to sense new alarm conditions.

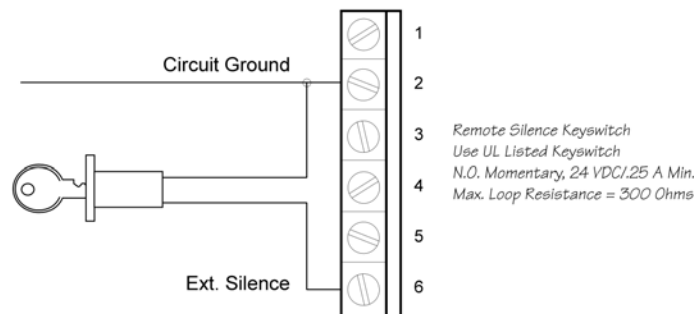

Figure 6-12 Wiring an External Silence or Reset Alarms Keyswitch

The external keyswitch silences notification devices and horns only, not the onboard beeper or local annunciators. See Section 7.1.3 if you need additional information.

If using a pushbutton reset, it must be placed within a firefighter's lockbox.





---

## Section 7

# Normal Operation

---

The optional Model 5230 Remote Annunciator provides annunciation of trouble and alarm conditions, and can be used to program the system. Key functions for both the Model 5230 (Figure 7-1) and the 5204 built-in touchpad (Figure 7-2) are described in Section 7.1. Section 8 explains how to program the 5204 using the Model 5230.

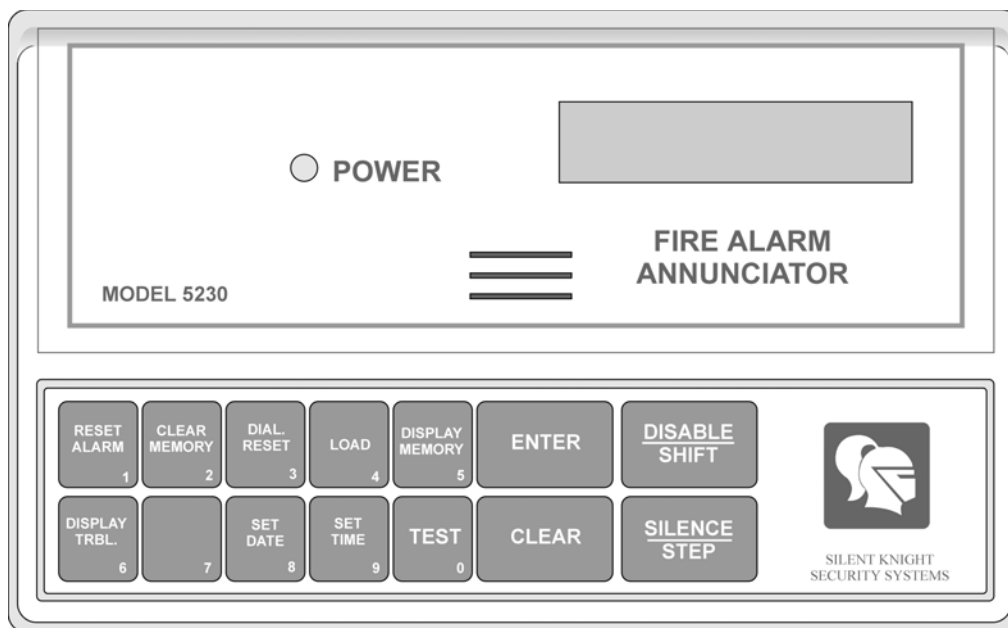

**Figure 7-1 Model 5230 Remote Annunciator**

The Model 5230 Remote Annunciator has a liquid crystal display (LCD) for displaying English-language messages. If the 5204 is not being programmed, the LCD cycles through all messages that are applicable at the time, showing a different one every 1.5 seconds. Refer to Section 9.3 for more information on troubleshooting messages.

When AC power is being supplied, and the battery is fully charged, the POWER LED glows steadily. If the POWER LED is flashing, the AC power has been removed or the backup battery is low. If neither AC nor battery power is being supplied, the POWER LED is off.

The audio transducer buzzer produces short beeps to annunciate keystrokes. It also emits a long, high-pitched tone to denote a trouble condition or to indicate that an annunciator function has been entered incorrectly (see Section 7.1).

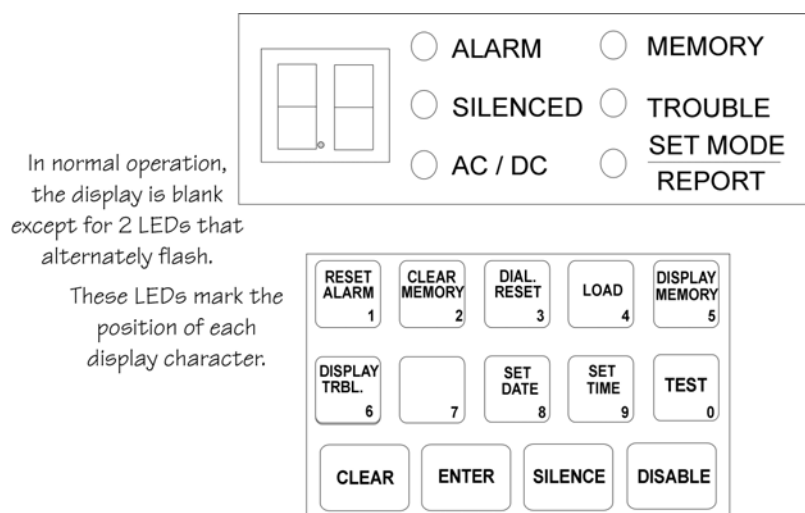

Figure 7-2 Built-in Touchpad

## 7.1 Built-in Touchpad and Model 5230 Annunciator Operation

To operate the 5204, you must use either the built-in touchpad or the Model 5230 Remote Annunciator. This annunciator functions the same as the internal touchpad except for the STEP key. The installer uses this key to step through programming options (see Section 8.3).

































Following are the basic operating functions. Note that if no keys are pressed for 15 minutes while in program mode, the system will time out and resume normal operation.

The message TRY AGAIN appears on the 5230 display if you do not press any keys for 5 seconds while accessing a function, or, if you attempt to access a function before exiting from another function.























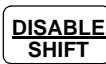



















In the following table, Code 0 refers to the installer's code (factory programmed as 5204). Code 1 refers to the operator's code (factory programmed as 1111). These two codes are described in Step 45 and Step 46 of Step Programming (see Section 8.4.1).

Note: A valid operating code is always required when using the 5230.





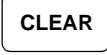
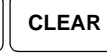







**Table 7-1: Touchpad Operations**

To:	Press:		Additional Information
	5230 Annunciator	Built-in Touchpad	
Clear			Enables you to start again if you enter the wrong keystrokes. If you enter a function incorrectly on the 5230, the annunciator's PZT buzzer will emit a long, high-pitched tone.
Test the system	  + code 0 or 1	 	The system will test the 4180 outputs, the built-in touchpad LED display, signaling devices, sirens, and communicator.
Reset alarms (or smoke detectors)	  + code 0 or 1	  + code 0 or 1	After a smoke alarm has been triggered, this function removes smoke detector power for the programmed length of time (as determined by the smoke detector). This allows the smoke detector to sense new alarm conditions.
When a trouble condition occurs and you reset the alarm, the trouble condition is stored in memory until you <u>clear</u> the alarm memory. If you do not clear the alarm memory, the trouble condition is displayed the next time a trouble condition occurs, implying incorrectly that more than one trouble condition exists.			
Clear alarm memory	  + code 0 or 1	 	Clears all data out of alarm memory and resets the 4180. (This function removes all memory of alarms.)
Reset the dialer	  + code 0	  + code 0	Aborts an in-progress call to the central station.
Initiate download	  + code 0	  + code 0	Starts the downloading process. Exit the DOWNLOADING mode by pressing CLEAR CLEAR.
Display alarm memory	  + code 0 or 1	 	Displays the current alarm memory. (It is recommended that you clear alarm memory after displaying it.)
Display troubles	  + code 0 or 1	 	Displays trouble conditions.
Silence trouble or alarm conditions	 + code 0 or 1		Silences signaling devices that are in trouble or alarm. (On-board beeper and local annunciators continue to sound until serviced. See Section 9.1 for more details.)

**Table 7-1: Touchpad Operations**

To:	Press:		Additional Information
	5230 Annunciator	Built-in Touchpad	
Fire drill	<p>   + code 0 or 1</p> <p>To end a fire drill:  + code 0 or 1</p>	<p>   + code 0</p> <p>To end a fire drill: </p>	Causes the system to sound an alarm and report a FIRE TEST.
Set time	<p> </p>	<p> </p>	Enter time in military time..
<p>The SET MODE LED will turn on and the built-in touchpad display will flash 9- indicating that you are in the SET TIME mode.</p> <p><b>Note:</b> The 5204 powers up in the SET TIME mode, with 9- showing on the display. If you wish to set the time at this point, it is not necessary to press the 9 ENTER (code) key sequence. Simply key in the appropriate digits. To exit the SET TIME mode, press ENTER.</p>			
Disable/Enable (shunting / unshunting)	<p>(Zone #1-4) +  + code 1 or 0</p>	<p>(Zone #1-4) +  + code 1 or 0</p>	Disables a zone (prevents it from responding to an alarm condition) or reactivates a disabled zone. When you disable, a trouble buzzer will sound.
<p><b>Note:</b> If the dialer is busy, modes 22, 25, and 27 are disabled. If you are in mode 22, 25, or 27, the dialer is disabled.</p>			
Walk test	<p>   + code 0 (factory programmed as 5204)</p> <p>To exit press:    </p>	<p>   + code 0 (factory programmed as 5204)</p> <p>To exit press:    </p>	Enables you to test the system. When you enter this mode, the LCD will indicate that you are in the Walk Test mode. When a zone is violated, the signaling device outputs will become active for approximately 6 seconds.
Zone Trouble-shooting mode	<p>   + code 0</p> <p>To exit press:    </p>	<p>   + code 0</p> <p>To exit press:    </p>	Enables you to locate and correct problems. The use of this mode is described in Section 9.2.2.

**Table 7-1: Touchpad Operations**

To:	Press:		Additional Information
	5230 Annunciator	Built-in Touchpad	
Step Programming mode	<p>    + code 0                      To exit press:       </p>	<p>    + code 0                      To exit press:      </p>	<p>Enables you to program 5204 options stored on the EE-PROM. Refer to Section 8.3 for instructions on using mode 27.</p>

### 7.1.1 Operating Modes

The following table describes which codes can access operating modes during alarms:

Operating Mode		Allowed During Alarm	Code Required	
			On 5230	On Built-in Touchpad
00	System test	No	Code 0 or 1	None
01	Reset alarm	Yes	Code 0 or 1	Code 0 or 1
02	Clear alarm memory	No	Code 0 or 1	None
03	Dialer reset	Yes	Code 0	Code 0
04	Download	No	Code 0	Code 0
05	Display alarm memory	No	Code 0 or 1	None
06	Display troubles	No	Code 0 or 1	None
09	Set time	No	Code 0 or 1	Code 0 or 1
2B	Silence mode	Yes	Code 0 or 1	None
20	Fire drill	No	Code 0 or 1	Code 0 or 1
22	Walk test	No	Code 0	Code 0
27	Program	No	Code 0	Code 0
25	Troubleshooting	No	Code 0	Code 0
E0	Disable/enable zone	Yes	Code 0 or 1	Code 0 or 1

### 7.1.2 Built-in Touchpad Display Codes

The built-in touchpad display shows the zones in which a trouble or alarm condition is occurring. It also displays two-digit codes that represent a variety of conditions, as an aid in troubleshooting the system. These codes are listed below.

The following table describes the codes that appear on the built-in touchpad:

Display	Explanation
0	Fire drill (with ALARM, ALARM MEMORY, or TROUBLE LED).
1 through 4	Zone numbers (with ALARM, ALARM MEMORY, or TROUBLE LED). A “c” in front of the number indicates a supervisory sprinkler zone.
E7	Indicates trouble with the EEPROM memory.
F0 F1 through F3	5230 annunciator power trouble. Indicates trouble with a particular annunciator.
A1 through A2	Indicates trouble with a particular bell output.
P3	P3 indicates a short between Earth Ground and Common Ground. To determine the location of the short, remove field wiring circuits until the control returns to normal operation. See Section 9.2.
P4	P4 indicates a short between Earth Ground and loop or bell power. To determine the location of the short, remove field wiring circuits until the control returns to normal operation. See Section 9.2.
P0	Indicates that the printer is out of paper.
dc Ac dF	Low battery condition. Low AC condition. Dialer failed to communicate or Data lost during an attempt to transmit data to the central station.
L1 L2	Phone Line 1 Fault Phone Line 2 Fault
-0 -2 -4 -5 -6 -7 -8 -9	Fire drill Walk test Downloading Zone test HEX PROGRAMMING mode STEP PROGRAMMING mode SET DATE mode SET TIME mode
2-, 3-, 4-, 5-, 6-, 7-, 8-, 9-	User must enter a code to perform the desired function with these prompts.

### 7.1.3 Silencing the System

To silence a trouble, press SILENCE.

To silence an alarm, follow these steps:

1. Disable the zone by pressing (zone number) + DISABLE + code 1 or 0.
2. Reset the system by pressing  ENTER + code 1 or 0.
3. The zone is now in trouble because of the disabled zone and can be silenced in the normal way by pressing SILENCE.

See Section 9.1 for related information.

### 7.1.4 LED Indicators

Six light emitting diodes (LEDs) appear in the 5204 cabinet window.

LED	Status	Condition
ALARM (red)	OFF	No alarm condition exists.
	ON	A fire alarm condition exists in the zones shown on the touchpad.
SILENCED (yellow)	OFF	An alarm or trouble has not been silenced.
	ON	An alarm or trouble condition exists and the audible annunciators have been silenced.
AC / DC (green)	OFF	Panel has lost all power.
	ON	Panel is running on AC and battery power (normal condition).
	FLASHING	Panel is running on battery power only or AC power only.
MEMORY (yellow)	OFF	No information is stored in alarm memory.
	ON	An alarm condition has been reset.
TROUBLE (yellow)	OFF	No trouble condition exists.
	ON	A trouble condition exists.
<u>SET MODE</u> (yellow) REPORT	OFF	Normal operating mode and not reporting.
	ON	System is in a SET (TEST or PROGRAM) mode.
	FLASHING	System is reporting





## 7.2 System Testing

---

System testing includes fire drills, zone testing, and 24-hour automatic tests.



### 7.2.1 Fire Drills (Mode 20)

You can run fire drills using either the built-in touchpad or the Model 5230 touchpad. To

initiate a fire drill, press   ENTER + code 0 or 1. The system will sound an alarm and report a fire test. To end the fire drill, press SILENCE) + code 0 or 1.

### 7.2.2 Walk Test (Mode 22)

The Walk Test mode enables you to test individual sensors.

To enter the Walk Test mode, press   ENTER + code 0 (factory-programmed as 5204). The LCD will indicate that you are in the Walk Test mode. When a zone is violated, the bell outputs will become active for approximately six seconds. During a walk test, smoke verification is disabled. Follow the manufacturer's directions for testing smoke and heat detectors. To violate a waterflow detector, open the waterflow valve.

Zones can be disabled individually to facilitate testing and troubleshooting. Disabled zones will NOT be tested. If no zones are tripped during the Walk Test (or keys pressed) for 15 minutes, the system will time out and resume normal operation.

To exit Walk Test mode, press STEP STEP CLEAR CLEAR. If using the built-in touchpad, press SILENCE SILENCE CLEAR CLEAR.

### 7.2.3 Automatic Self Test

The Model 5204 lets you select the time of day to send the 24-hour automatic test signal to the central station.

The Auto Test (Dialer test sent automatically at specified times) also sends all unrestored events, as now required by UL. Events listed before AUTO TEST on the printout at the central station are new events. Events listed after AUTO TEST are old events that have not been restored.

### 7.2.4 Watchdog Circuit

During normal operation, the control microprocessor of the 5204 is constantly running programs to check inputs and carry out other routine functions. If this program stops running for some reason, the watchdog circuit will automatically attempt to resume normal operation by resetting the microprocessors. Each time the watchdog circuit initiates a reset signal, it will also sound the audible trouble signal for approximately four seconds.

## 7.3 Zone Characteristics

---

This section describes the programmed characteristics of zone inputs. Zone characteristics include zone type, cross alarm, pre-alarm, smoke verification, and zone response time.

### 7.3.1 Zone Type

If the 5204 should supervise a sprinkler system, select the zone as “sprinkler” even if dialer/reporting has not been selected.

Undefined zones may be used to supervise the functioning of a commercial process (such as manufacturing operations, temperature control for heating or refrigerating systems, and so on), when failure of the supervised process could result in fire or explosion endangering life or property. Audible indicators for Fire and Waterflow zones override audibles for undefined zones.

If you are using waterflow switches with built-in delays, note that zone response time must not exceed 120 seconds.

## 7.3.2 Cross Alarm

Cross alarm areas require a minimum of 2 detectors on 2 different zones.

Do NOT select this feature if smoke verification has been selected in Steps 25-28.

If a zone is programmed for cross alarm and an alarm condition occurs in this zone, relay 1 will be activated. An alarm sound or report will not be generated until an alarm condition also occurs in one of the other zones.

If an alarm has already been activated on the other zone, and an alarm subsequently occurs in a cross-alarm zone, the cross-alarm programming will be ignored. The alarm condition in the cross-alarm zone will immediately generate an alarm sound and report.

### Example

In the following example, various combinations of alarm conditions are shown and whether an alarm sound or report is generated.

**Table 7-2**

Alarm Condition Exists in Zones:	Alarm Generated?	Alarm Generated?
	(Cross Alarm #1 Selected)	(Cross Alarm #1 and #3 Selected)
1	No	No
1,2	Yes	Yes
1,2,3	Yes	Yes
1,2,3,4	Yes	Yes
2	Yes	Yes
2,3	Yes	Yes
2,3,4	Yes	Yes
3	Yes	No
3,4	Yes	Yes
4	Yes	Yes

When using cross alarm, be sure to place smoke detectors so that no two adjacent detectors

belong to the same zone. Refer to the following diagram:

Distribution of Smoke Detectors  
in a Cross Alarm Installation  
(Numbers signify zone numbers)

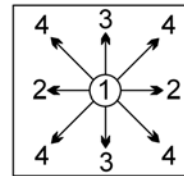
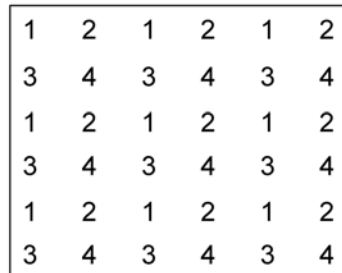

Close-up view of smoke detector distribution. No zone 1 detectors are adjacent to any other zone 1 detectors.

Distribution of detectors for cross alarm in a large open area with 4 zones. For a smaller installation, use any segment of this example

If you are installing an NFPA 72 Protected Fire Alarm system, do not use the cross alarm and alarm verification features in the same installation (you can use one or the other, but not both).

Local Protected Fire Alarm systems that require the activation of two smoke detectors to produce the alarm response shall be permitted, providing:

1. They are not prohibited by the authority having jurisdiction.
2. There are at least two detectors using two different zones in each protected space.
3. Detector spacing is no more than one half that determined by the application of NFPA 72, *Standard on Automatic Fire Detectors (NFPA National Fire Alarm Code, 1993 Edition, Chapter 5)*.
4. The alarm verification feature is not used.

### 7.3.3 Pre-Alarm

This option programs the number of seconds (5-45) on alarm will be delayed. See description of “pre-alarm” in Steps 19-22.

Alarm bells and reporting will be delayed in zones 1-4 (respectively). Gives an audible tone that the system is about to go into alarm (Yes or No). Can be used to allow for immediate evacuation. (Duration of delay programmed in Step 18.)

## 7.3.4 Smoke Verification

In UL installations, the total delay, including detector built-in start-up time and programmed reset time, must not exceed 60 seconds. To help you determine the maximum length you can select for smoke verification time, use the following calculation:

$$60 - [\text{detector start-up time} + \text{detector reset time}] = \text{smoke ver. time}$$

If you are installing NFPA 72 Local Protected Fire Alarm system, do not use the cross alarm and alarm verification features in the same installation (you can use one or the other, but not both).

Refer to your smoke detector documentation for start-up and reset times. Reset times are also listed in Table 6-2 and Table 6-3.

Do NOT select this feature if cross alarm has been selected in Step 15-Step 18.

Figure 7-3 shows the timing of the smoke verification process:

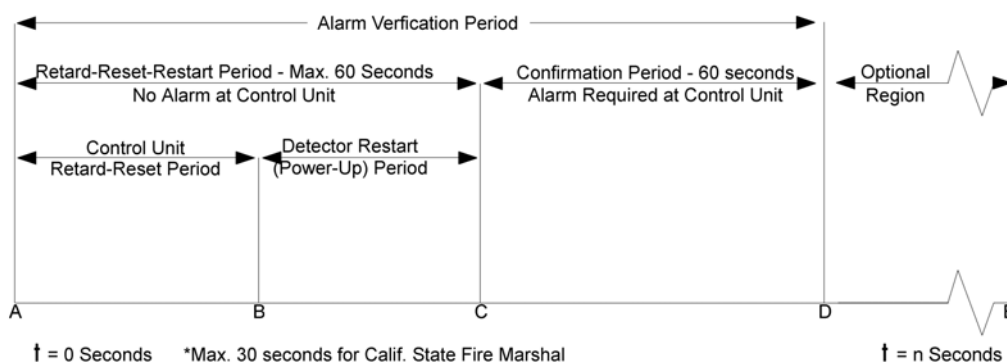

- A - Smoke detector goes into alarm.
- AB - RETARD-RESET PERIOD (Control Unit) - Control unit senses detector in alarm and retards (delays) alarm signal, usually by de-energizing power to the detector. Length of time varies with design.
- BC - RESTART PERIOD (Detector Power-Up Time) - Power to the detector is reapplied and time is allowed for detector to become operational for alarm. Time varies with detector design.
- AC - RETARD-RESET-RESTART PERIOD - No alarm obtained from control unit. Maximum permissible time is 60 seconds.
- CD - CONFIRMATION PERIOD - Detector is operational for alarm at point C.  
If detector is still in alarm at point C, control unit will alarm.  
If detector is not in alarm, system returns to standby. If the detector goes into alarm again at any time during the confirmation period, the control unit will go into alarm.
- DE - OPTIONAL REGION - Either an alarm can occur at the control unit, or the alarm verification cycle can restart.
- AD - ALARM VERIFICATION PERIOD - Consists of the retard-reset-restart and confirmation periods.

**Figure 7-3 Smoke Verification Process**

## 7.3.5 Zone Response Time

The zone (loop) response time for trouble conditions is 3 to 4 seconds.

### Requirements/Restrictions

- The delayed responses (speeds 1-3) are NOT intended to be an alarm verification feature.
- Delays may be used ONLY on waterflow switches. The zone response time must not exceed 120 seconds for waterflow switches that have their own delay.
- Class B (style B) zones must be programmed as “1”.
- Do NOT enter any numbers other than 0-3. Doing so will cause the 5204 to default to one of these four speeds.



---

## Section 8

# Programming

---

The Model 5204 system can be programmed for specific customer needs through the use of programming options.

Using Step Programming or downloading, you can reprogram the options that are stored on an Electrically Erasable Programmable Read Only Memory (EEPROM) chip. Step Programming (Section 8.3) is available through the Model 5230 Remote Annunciator and the built-in touchpad.

If your system includes the Model 5205 Dialer Module, you can also use the Model 5541 Downloading software (Section 8.2).

This section explains programming only; refer to Section 7 for basic operating instructions.

### 8.1 EEPROM Information

---

The EEPROM is used to store all of the system options, such as system configuration, telephone numbers, reporting formats, account numbers, and so on. The EEPROM is an 8-pin integrated circuit chip that can be reprogrammed up to 1000 times. It will retain programmed information even after a total loss of power. Default values for all options are preprogrammed into the EEPROM before it leaves the factory. These default values are listed in the Quick Reference table in Appendix A.

#### **Caution**

Do NOT attempt to use the step programming feature with a blank EEPROM. You MUST use an EEPROM that contains the default data or one that has been previously programmed. The 5204 is shipped from the factory with an EEPROM programmed with default data.

To order EEPROMs, call Silent Knight Sales at (800) 446-6444. The number to use when ordering is 009355.



## 8.2 Downloading

---

The Model 5541 Downloading software (Revision 3.33 or higher) enables you to use a computer at a remote location to reprogram options at a particular installation.

*Note: Revision 3.7 (or later) of the downloading software is required if you wish to report sprinkler supervisory event codes to the central station. See Step 56-Step 61 for more details.*

The downloading software is organized into menus. As you move through the menus, the screens tell you how to select options. The programming options are described in detail in Section 8.4. For complete information on using the software, see the Model 5541 Downloading Software Manual (P/N 150497).

After the 5204 accepts all the new data, the 5204 will transmit the message PROGRAMMING PASS in SIA format to the 9000 receiver. UL requires the central station to send a representative to the site to verify the programming changes. (If the 5204 does NOT accept all the new data, the 9000 will print the message, PROGRAMMING FAIL.)

To be able to print PROGRAMMING PASS or PROGRAMMING FAIL, the 9000 must have Model 9307 software package, Revision 900501 or later.

This software can be used only with the Model 9200-E CPU card. (If you need information about how to contact Silent Knight for an upgrade, see Section 8.1.)

## 8.3 How to Use Step Programming

---



You can access Step Programming (also known as mode 27) using either the Model 5230 Remote Annunciator or the built-in touchpad to program options. The Step Programming form in this section describes the options and how to program using either method.



If your 5204 installation does not include the Model 5230, it is possible to connect a temporary annunciator for programming on the 5204 circuit board. Refer to Section 5.8 for more details.

If no key is pressed for four minutes while in programming mode, the system will exit programming mode.

When you key in a function very quickly, wait for the message to appear on the display before you press the ENTER key.

### 8.3.1 Entering Step Programming (Mode 27)

1. Read through the options in this section to determine what selections you wish to make for each option. For future reference, you can write down your selections in the Quick Reference table in Appendix A.
2. Enter the Step Programming mode by pressing   ENTER + code 0 (factory-programmed as 5204). If you have entered mode 27 correctly, the following information will appear in the display:

Model 5230	Built-in Touchpad
The first line of the LCD will show the programming option for step 1. The second line will show the most recently programmed value for that option. For example: 24-V SMOKE POWER YES	Depending on whether step 1 is programmed as Yes or No, the display will show either of the following:  or  (The default is Y.)









If you get a trouble beep and the message TRY AGAIN appears, either you are not using the correct code 0, or the EEPROM could be malfunctioning. To correct this problem, you must obtain a new default EEPROM (see Section 8.1 for ordering details).

### 8.3.2 Programming Options

For selecting options, entering digits works as follows:

- Scroll                      For most options, you enter numbers in the same way as if you were using a calculator. The digits appear on the right side of the display and scroll to the left as you continue to enter data.

To program an option, key in the data you have written on the Quick Reference table in Appendix A for that option.





Model 5230	Built-in Touchpad
<p>The second line of the LCD will show the new value. For example, if you changed the default setting of Yes for Step 1 to No, the display would appear as follows:</p> <p>24-V SMOKE POWER NO</p> <p>Press . The display will advance to the next step.</p> <p>To select Yes or No Press any digit to toggle the Yes/No option.</p>	<p>The display will show the first digit of the new data. Press . The display will show the first digit of the next step. If the data includes more than two digits, the left most digit will shift off the display each time you key in a new digit. For example: Suppose you want to program ACCOUNT #1 (Step 66) as 123456. After you key in  , the display will show . After you key in , the display will show . After you have keyed in all six digits (but before you have pressed , the display will show .</p>

### 8.3.3 Advancing to the Next Option

To skip a step, press ENTER. The data in the skipped step will not change.



Model 5230	Built-in Touchpad
The LCD will show the next option.	The display will show the previously programmed data for the next step.

### 8.3.4 Going to a Specific Step

Model 5230	Built-in Touchpad
<p>The LCD will show the option name. Press  to continue programming that step.</p> <p>Press STEP) to go to a specific step. The first line of the LCD will show ENTER THE STEP # and the current step number. Key in the new step number, followed by . The LCD will show the new option name.</p> <p><b>Note:</b> If you try to go to a step that does not exist, the display will go back to the previous step.</p>	<p>Press . The display will show the step number and the ALARM LED will light. The display indicates the current step number. Press  to continue programming that step.</p> <p>To go to a specific step, enter the new step number. The display will show the previously programmed data for the new step, and you can now continue programming this step.</p> <p><b>Note:</b> If you try to go to a step that does not exist, the display will go back to the previous step.</p>

### 8.3.5 Viewing Previously Programmed Data

To view the previously programmed data for a particular step (in other words, you have not entered any new data), go to the step as explained in Section 8.3.4.













Model 5230	Built-in Touchpad
The data for that step will show on the second line of the LCD.	The display will show the first digit. If the data includes more than one digit, press  to view the next two digits. Press  as often as necessary until you have viewed all the digits.

### 8.3.6 Correcting Errors

Press the CLEAR key to erase the step number or when you make a mistake when entering data. If you have not yet touched the ENTER key, press the CLEAR key. Key in the correct data and press ENTER.

### 8.3.7 Entering Hexadecimal Digits

To enter numbers greater than 9, use the SHIFT key as shown below to enter numbers 10-15. Hexadecimal digits (in parentheses) appear on the screen to represent these numbers:

From The 5230	From the Built-In Touchpad
  = 10 (A)	  = 13 (D)
  = 11 (B)	  = 14 (E)
  = 12 (C)	  = 15 (F)



## 8.3.8 Programming Examples

The following examples may help you to understand how to use Step Programming. The selections you make in each installation will vary depending on each customer's needs. The way you move through Step Programming may also vary from how it is described here.

The following examples assume you are at the Step 1 display (see Section 8.4.1).

### Example 1: Choosing a Programming Option from a Menu

Suppose you want to program the 5204 so that Bell #2 will pulse in Zone #3.

1. Press STEP   ENTER to go to Step 42.
2. The following display will be shown:



<u>Model 5230</u>	<u>Touchpad</u>
BELL#2 ZONE #2 STEADY	

3. Press  for PULSE.
4. Press ENTER).

### Example 2: Programming Location Description Names

Suppose you want to program the Model 5230 Annunciator to display meaningful location names for Zones 2 and 4. The words you wish to display are GARAGE for Zone 2 and EAST OFFICE for Zone 4. You can select these words from the 5230 library of names using Step Programming. See Table 8-2 for a complete list of words contained in the library.



- Programming a One-Word Display

1. In programming mode, press STEP   ENTER to go to Step 12.
2. Press  repeatedly until the word GARAGE displays on the LCD. Press ENTER to select.

- Programming a Two-Word Display







To program Zone 4 to display EAST OFFICE, you will have an additional step since you are programming two words instead of one.

1. In programming mode, press   ENTER to go to Step 14.

2. Press  repeatedly until the word EAST displays on the LCD.
3. To add the second word, press  until you reach OFFICE. Press ENTER to select.

### 8.3.9 Exiting Step Programming

At any time while using Step Programming, you can exit mode 27 by pressing:

From The 5230				From The Built-in Touchpad			
							

## 8.4 Step Programming Options

This section explains the options you can program for the Model 5204 panel. Before you begin step programming, read through this and write down the selections you wish to make on the perforated form provided in Appendix A.

For each option, the values programmed at the factory (defaults) are shown in the sample displays. The valid input selections are in parentheses in the Option Descriptions column. If you do not reprogram a particular option, the default values will be in effect.

These options are listed in the order in which they appear on the 5230 annunciator. When you are using the built-in touchpad or the Model 5541 downloading software menus, the order and the option names vary slightly.





### 8.4.1 Programming Steps

Table 8-1 lists all the steps numbers, what is displayed, and the choices available in those steps.

**Table 8-1: List Of Programming Steps**

Step #	Displayed Information		Description
	On the 5230	On the Built-In Touchpad	
Step 1	24-V SMOKE POWER	<input type="checkbox"/> Y	Select this option if you want the 5204 to provide 24 V of smoke power. If this option is not selected, the 5204 will provide 12 V of smoke power. (Yes or No) Y = 24 V panel N = 12 V panel
Step 2	EXTERNAL SILENCE	<input type="checkbox"/> Y	This option controls the external input that can be used to silence audible alarms or to reset alarms (Yes or No). If an external keyswitch has been wired, Yes = Silences alarms No = Resets alarms
Step 3	#SUPER ANNUNC	<input type="checkbox"/> 0	This number (0-3) specifies the number of annunciators that will be supervised. If 0 is selected, it is possible to use all three annunciators, but none will be supervised.
Step 4	SMOKE RESET TIME	<input type="checkbox"/> 2	Enter (2-7 seconds) the length of time power is removed from the smoke detector after it has been reset (see Section 7.1). <b>Note:</b> Manually silencing the annunciators by pressing SILENCE) (code 1 or 0), does NOT reset the smoke detector. To remove and return power, so the smoke detector can continue to sense alarm conditions, press 1)ENTER). See the tables in Section 6.1 for the smoke reset time required for each smoke detector model.
Step 5	ZONE DISABLE	<input type="checkbox"/> Y	Selections are the following: Yes = All zones can be disabled. No = Zones cannot be disabled.

**Table 8-1: List Of Programming Steps**

Step #	Displayed Information		Description
	On the 5230	On the Built-In Touchpad	
Step 6	LATCH SPRINKLER		Set how the sprinkler zone will operate. Press any numeric-digit to toggle the selection from Yes to No. Yes = When the sprinkler zone shorts for a duration longer than the Zone Response (set in steps 30 through 33), the annunciator remains active until reported or manually silenced. No = When the sprinkler zone shorts for a duration longer than the Zone Response (set in steps 30 through 33), the zone will follow system status and indicate a supervisory on that zone for the duration of the faulted condition.
Step 7	ZONE TYPE:#1		Selects the zone type for zones 1-4 respectively. This is the zone type that will be reported when the zone is activated, if the Model 5205 and a SIA reporting format is used. Possible zone types are the following: 0 = Fire 1 = Waterflow 2 = Undefined 3 = Sprinkler
Step 8	ZONE TYPE:#2		
Step 9	ZONE TYPE:#3		
Step 10	ZONE TYPE:#4		
Step 11	LOCATION ZONE#1	[Blank]	Enter a two-word location description for zones 1-4. Select the words from the list below. If you are programming with the built-in touchpad, use the SHIFT key to advance to the corresponding two-digit number.  Press 1) as many times as necessary to advance through the word list for the first word. (Press 6) to go backwards through the word list to choose the first word.)  Press 2) as many times as necessary to advance through the word list for the first word. (Press 7) to go backwards through the word list to choose the first word.)  OR 1. Press SHIFT) 2. Press 1) or 2) (for first or second word) 3. Press digit for number of word from word list. See Table 8-2 for complete word list.
Step 12	LOCATION ZONE#2		
Step 13	LOCATION ZONE#3		
Step 14	LOCATION ZONE#4		
Step 15	CROSS ALARM#1		If this option is selected, Yes = An alarm condition will not be sounded or reported until an alarm condition exists in another zone. No = Alarm in zone sounded or reported immediately. Cross alarm areas require a minimum of 2 detectors on 2 different zones.
Step 16	CROSS ALARM#2		
Step 17	CROSS ALARM#3		
Step 18	CROSS ALARM#4		
Step 19	PRE-ALARM TIME		This option programs the number of seconds (5-45) on alarm will be delayed. See description of “pre-alarm” in Step 20-Step 23.



**Table 8-1: List Of Programming Steps**

















Step #	Displayed Information		Description
	On the 5230	On the Built-In Touchpad	
Step 20	PRE-ALARM #1		Alarm bells and reporting will be delayed in zones 1-4 (respectively). Gives an audible tone that the system is about to go into alarm (Yes or No). Can be used to allow for immediate evacuation. (Duration of delay programmed in Step 19.) See Section 7.3.3 for more details.
Step 21	PRE-ALARM #2		
Step 22	PRE-ALARM #3		
Step 23	PRE-ALARM #4		
Step 24	SMOKE VER TIME		Enter the duration of the smoke detector delay (5-18 seconds). See Section 7.3.4 for more details.
Step 25	SOUND SMOKE VERIFY		If this option is selected, there will be an audible trouble signal whenever a smoke detector enters its verification period before causing an alarm (Yes or No). The duration of this delay is programmed in Step 24. See Section 7.3.4 for more details.
Step 26	SMOKE VERIFY #1		If you select this option, zones 1-4 respectively will be controlled by the smoke detector delay that was programmed in Step 24 (Yes or No). Do NOT select this feature if cross alarm has been selected in Step 15-Step 18. See Section 7.3.4 for more details.
Step 27	SMOKE VERIFY #2		
Step 28	SMOKE VERIFY #3		
Step 29	SMOKE VERIFY #4		
Step 30	ZONE RESPONSE#1		Select the speed at which zones #1-4 will respond to alarm conditions (0-3). The following speeds are associated with each selection: 0 = 0.3 to 0.4 sec. 1 = 3 to 4 sec. 2 = 15 to 20 sec. 3 = 30 to 40 sec. The zone (loop) response time for trouble conditions is 3 to 4 seconds. See Section 7.3.5 for more details.
Step 31	ZONE RESPONSE#2		
Step 32	ZONE RESPONSE#3		
Step 33	ZONE RESPONSE#4		
Step 34	RELAY #2		Controls what relay #2 will activate (0-3). 0 = Relay #2 activates ALARM. 1 = Relay #2 activates TROUBLE. 2 = Relay #2 activates 5220 Direct Connect Module. 3 = Relay #2 activates 5220 City Box.
Step 35	BELL #1 SILENCED		Select this option to enable notification device #1 to be silenced by pressing the SILENCE key (Yes or No).
Step 36	BELL #1 ZONE #1		These options control the disposition of notification device #1 in zones 1-4 respectively (0-4). 0 = Steady 1 = Pulse (.5 seconds on, .5 seconds off) 2 = Temporal (3.5 seconds on, .5 seconds off, 3.5 seconds on, .5 seconds off) 3 = Supervisory (1 second on, 2 seconds off) 4= ANSI Temporal 5 = Not used
Step 37	BELL #1 ZONE #2		
Step 38	BELL #1 ZONE #3		
Step 39	BELL #1 ZONE #4		









Table 8-1: List Of Programming Steps

Step #	Displayed Information		Description
	On the 5230	On the Built-In Touchpad	
Step 40	BELL #2 SILENCED		Select this option to enable notification device #1 to be silenced by pressing the SILENCE key (Yes or No).
Step 41	BELL #2 ZONE #1		These options control the disposition of notification device #1 in zones 1-4 respectively (0-4). 0 = Steady 1 = Pulse (.5 seconds on, .5 seconds off) 2 = Temporal (3.5 seconds on, .5 seconds off, 3.5 seconds on, .5 seconds off) 3 = Supervisory (1 second on, 2 seconds off) 4= ANSI Temporal 5 = Not used
Step 42	BELL #2 ZONE #2		
Step 43	BELL #2 ZONE #3		
Step 44	BELL #2 ZONE #4		
Step 45	INSTALLER'S CODE		The installer's code. This 4-digit code (also known as Code 0) is used by the installer to initiate downloads (see Section 7.1), set the time, and enter the programming mode on the Model 5230 Annunciator. It can also be used to perform the same functions as code 1. (Factory-programmed as 5204.)
Step 46	OPERATOR'S CODE		The operator code. This 4-digit code (also known as Code 1) is used by the operator to silence annunciations and perform manual tests. (Factory-programmed as 1111.)
Step 47	DIALER TYPE		This option indicates the type of dialer used (0-3). 0 = Model 5205 Dialer NOT used 1 = USA 2 = 9000 Direct (do not select) 3 = European (used for Europe and Asia)
Step 48	COMPUTER ENABLE		If the downloading computer is to be used for programming and status request, you must select the COMPUTER ENABLE option. Press any number to toggle between Yes or No.
Step 49	GROUND START		Select this option if you want to use ground start phone line instead of loop start (Yes or No). Yes (Ground Start); No (loop start). Do NOT select ground start in UL installations. The ground start option requires the optional Model 2608 relay. (See Section 5.7 Figure 5-3.)
Step 50	TOUCHTONE LINE 1		This option determines whether the 5205 line #1 will use rotary dialing, or try both Touch-Tone and rotary dialing when trying to send a report (Yes or No). Press any number to toggle between Yes or No.
Step 51	TOUCHTONE LINE 2		

**Table 8-1: List Of Programming Steps**

Step #	Displayed Information		Description
	On the 5230	On the Built-In Touchpad	
Step 52	MUST REPORT #1		<p>When the 5204 generates a report, it attempts to send the report to the priority central station phone number (see Steps 61-64). If the priority phone number is not available, the system tries the other phone number. It continues to alternate between the two phone numbers until the report is sent to one of the phone numbers.</p> <p>If account #2 is the first central station number available, the report will go to account #2. However, if the MUST REPORT #1 option has been selected, the system will continue to try to send the report to account #1, until account #1 is also available. Selections are:</p> <p>Yes = Always send reports to central station account #1.                      No = If another phone # is available first, no report to account #1.</p>
Step 53	MUST REPORT #2		<p>If account #1 is the first central station number available, the report will go to account #1. However, if the MUST REPORT #2 option has been selected, the system will continue to try to send the report to account #2, until it has either succeeded, or exhausted the programmed number of attempts (see Steps 67 and 72), leading to a dialer-failed condition. Selections are:</p> <p>Yes = Always send reports to central station account #2.                      No = If another phone # is available first, no report to account #2.</p>
Step 54	AC LOSS HOURS		<p>Using hexadecimal digits, select the number of hours that the AC power must be removed from the panel before the AC power loss is reported to the central station (6-15). If AC power is restored and lost again during this time period, the system will reset the time to 0 and start counting again.</p> <p>To enter hexadecimal numbers 10-15,                      Press SHIFT 1 -SHIFT 6.                      Do NOT select fewer than 6 or more than 12 hours for NFPA 71.                      For NFPA 72 Central Station Fire Alarm systems, set to 6-12 hours; for NFPA 72 Polarity Reversal, set to 15 hours.</p>
Step 55	# RINGS		<p>If the downloading software (Model 5541) is to be used, this option determines the number of times the phone line will ring before the 5204 will answer the call. The allowable number of rings ranges from 2 to 14. If you select fewer than 2 rings, the 5204 will not answer. Use hexadecimal digits to program this step.</p> <p>If downloading is used, you must select the COMPUTER ENABLE option (Step 48).</p>

Table 8-1: List Of Programming Steps

Step #	Displayed Information		Description
	On the 5230	On the Built-In Touchpad	
Step 56	3/1 ALARM CODE		<p>Six types of events (alarm, sprinkler, trouble, disable, restore, and test) can be reported to the central station receiver. When transmitting this data using 3/1 format, each event is represented by a single digit.</p> <p>For each event, select a digit from 0-9 to identify that particular event to the receiver. The letters A (SHIFT 1) through E (SHIFT 5) can also be used if the receiver is capable of receiving them.</p> <p>Note also:</p> <ul style="list-style-type: none"> <li>When using the 3/1 format, the receiver does not distinguish between 0 and A.</li> <li>When using the 3/1 format, much of the 5204's reporting ability is lost because you are limited to 1 digit to report an event. For example, the report does not indicate in which zone the event occurred.</li> <li>If you are not using a 3/1 format, press the ENTER key as many times as necessary until you reach Step 62, ALARM #1 FIRST</li> </ul>
Step 57	3/1 SPRINKLER CODE		
Step 58	3/1 TROUBLE CODE		
Step 59	3/1 DISABLE CODE		
Step 60	3/1 RESTORE CODE		
Step 61	3/1 TEST CODE		
Step 62	ALARM #1 1ST		<p>In Steps 61-64, you select the priority phone number for sending each type of report. That is, you select the phone number the 5204 will try to send the report first. Selections are:</p> <p>priority phone number will be #1 (Yes), or priority phone number will be #2 (No).</p> <p>If the priority phone number is not available, the 5204 will try to report to the other phone number. It continues to alternate phone numbers until it succeeds in sending the report to one of the phone numbers. If you want to be sure that the system will always report to a particular phone number (regardless of which number it reports to first), see Steps 52 and 53.</p> <p>Alarms and their restorals are reported on zones 1-4.</p>
Step 63	TROUBLE #1 1ST		<p>The 5204 reports AC trouble, battery trouble, earth ground trouble, phone line #1 and #2 trouble, annunciator 1-3 trouble, and zone 1-4 trouble. Select this option if you want the system to try central station account #1 first when reporting troubles and trouble restorals. (See also Step 62.) Selections are:</p> <p>Yes = Try to report troubles to central station account #1 first. No = Try to report troubles to central station account #2 first.</p>
Step 64	DISABLE #1 1ST		<p>Select this option if you want the system to try account line #1 first when reporting disabled zones. (See also Step 62.) Selections are:</p> <p>Yes = Report disabled zones to central station account #1 first. No = Report disabled zones to central station account #2 first.</p>



**Table 8-1: List Of Programming Steps**

Step #	Displayed Information		Description
	On the 5230	On the Built-In Touchpad	
Step 65	TEST #1 1ST	4	The 5204 reports manual and auto tests, and downloading successes and failures to the central station. Select this option if you want the system to try account line #1 first when reporting disabled zones. (See also Step 62.) Selections are: Yes = Try to report tests to central station account #1 first. No = Try to report tests to central station account #2 first.
Step 66	ACCOUNT #1	1	Enter account number for central station phone #1 (6 digits; leading zeros if shorter). Factory default account number = 105204.
Step 67	ATTEMPTS #1	3	Enter the number of times the 5204 will try to dial each central station account # before the DIALER TROUBLE message appears on the 5230 Annunciator (3-5). Normally, the dialer will switch back and forth between account numbers after each attempt. If a different number of tries has been programmed on each number, the DIALER TROUBLE message will appear after all the attempts have been used up for the account number programmed with the lowest number of attempts. However, the dialer will continue to try to report on the remaining number until it has made as many attempts as have been programmed for that number.
Step 68	FORMAT #1	5	Indicate the appropriate reporting format to be used on phone #1 (0-7). The numbers correspond to the formats described below. Refer to Section 10 for more information on reporting formats. 0 = SIA8. Security Industry Association standard. 1 = FSK81. Silent Knight FSK format. Uses a 4-digit account number 2 = SK4+2. 20 pps pulsed-tone format. Uses a 4-digit account number. 3 = BFSK14. Format used with receivers that can receive BFSK and send a 1400 Hz acknowledgment tone. Uses a 3-digit account number. 4 = BFSK23. Format used with the Model 9000 receiver and other receivers that can receive BFSK and send a 2300 Hz acknowledgment tone. Uses a 3-digit account number. 5 = SIA20. Security Industry Association standard. 6 = 3/1 14 (6). Used with older Silent Knight, Ademco, or SESCOA receivers that send a 1400 Hz acknowledgment tone. The Model 9000 receiver also accepts this format. 7 = 3/1 23 (7). Used with older SESCOA or other receivers that send a 2300 Hz acknowledgment tone. The Model 9000 receiver also accepts this format. <b>Note:</b> This SIA formats are the preferred formats for the 5204, and are required if using the computer downloading feature.

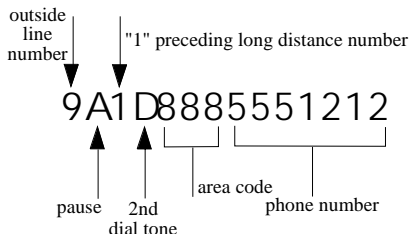
**Table 8-1: List Of Programming Steps**

Step #	Displayed Information		Description
	On the 5230	On the Built-In Touchpad	
Step 69	CIC #1	[Blank]	Carrier Identification Code is the prefix that needs to be dialed before a phone number to access a particular long distance carrier. Use special characters to add pauses, #, *, and "look for second dial tone" characters into the phone number. Enter A (SHIFT 1) for a pause. Enter B (SHIFT 2) for an asterisk (*). Enter C (SHIFT 3) for a number symbol (#). Enter D (SHIFT 4) to look for 2nd dial tone.
Step 70	PHONE #1	1	Enter a phone # up to 16 digits long. Enter A (SHIFT 1) for a pause. Enter B (SHIFT 2) for an asterisk (*). Enter C (SHIFT 3) for a number symbol (#). Enter D (SHIFT 4) to look for 2nd dial tone. Any unassigned spaces will automatically be programmed as F. 
Step 71	ACCOUNT #2	2	Enter the account # for central station phone #2 (6 digits; leading zeros if shorter). Factory default account number = 205204
Step 72	ATTEMPTS #2	3	See Step 67 (3-5)
Step 73	FORMAT #2	5	See Step 68 (0-7)
Step 74	CIC #2	[Blank]	See Step 69
Step 75	PHONE #2	2	Enter a phone # up to 16 digits long (see Step 70). Enter A (SHIFT 1) for a pause. Enter B (SHIFT 2) for an asterisk (*). Enter C (SHIFT 3) for a number symbol (#). Enter D (SHIFT 4) to look for 2nd dial tone. Any unassigned spaces will automatically be programmed as F.
Step 76	COMPUTER ACCOUNT	00	Program the account number (6 digits; leading zeros if shorter) you want to use when uploading or downloading. When calling the computer, the 5204 uses phone line 1 and makes only one attempt.
Step 77	COMPUTER CIC	[Blank]	See Step 69

**Table 8-1: List Of Programming Steps**

Step #	Displayed Information		Description
	On the 5230	On the Built-In Touchpad	
Step 78	COMPUTER PHONE		See Step 70
Step 79	TEST TIME		<p>Enter the time of day time using the 24-hour military format (4 digits) that you wish to send a TEST report to the central station.</p> <p>Note that any events that have not been restored will be sent along with the TEST report. The TEST will report first followed by the unrestored events.</p>
Step 80	CURRENT TIME	[Blank]	<p>Enter the current time using the 24-hour military format (4 digits). It is advisable to check the time every few months, and reset it if necessary.</p> <p><b>Note:</b> When using the Model 5541 downloading software, use the View Status menu to set the time. Refer to the Model 5541 Downloading Software manual (P/N 150497) for more information.</p>

**Table 8-2: Programmable Word List**

Option Number and Corresponding Word		
00 Blank	31 EQUIPMENT	62 REMOTE
01 # 1	32 EXIT	63 REST
02 # 2	33 1ST	64 ROOF
03 # 3	34 1ST FLR	65 ROOM
04 # 4	35 FLOOR	66 2ND
05 # 5	36 4TH	67 2ND FLR
06 # 6	37 4TH FLR	68 SENSOR
07 # 7	38 FRONT	69 SHIPPING
08 # 8	39 GARAGE	70 SHOP
09 # 9	40 GATE	71 SMOKE
10 # 10	41 GENERATOR	72 SOUTH
11 AC	42 GROUND	73 SPRINKLER
12 ACCOUNT	43 HALL	74 STAGE
13 ALARM	44 HEAT	75 STAIRWELL
14 AREA	45 HVAC	76 STORAGE
15 ATTIC	46 LAB	77 SUPER
16 BACK	47 LEVEL	78 TAMPER
17 BANQUET	48 LOADING	79 3RD
18 BASEMENT	49 LOBBY	80 3RD FLR
19 BOILER	50 LOCATION	81 TROUBLE
20 CELL	51 LOFT	82 UPPER
21 CENTER	52 LOWER	83 VALVE
22 COMPUTER	53 LUNCHROOM	84 VAULT
23 CONFERENCE	54 MECHANICAL	85 WAREHOUSE
24 DOCK	55 MEZZANINE	86 WATERFLOW
25 DOOR	56 NORTH	87 WEST
26 DUCT	57 OFFICE	88 WHSE
27 EAST	58 OPERATOR'S	89 ZONE
28 ELECTRICAL	59 PHONE	29 ELEVATOR
60 PULL	30 ENTRY	61 PULL STATION





---

## Section 9

# Troubleshooting

---

---

When the system is configured properly, the voltage readings on the input and output terminals should be the same as those shown in the terminal description in Section 5.6. Zone Troubleshooting (Section 9.2.2) can help you with this.

The factory-programmed value for code 0 is 5204; for code 1, it is 1111.

If the Model 9000 receiver prints HELP after downloading has taken place, you need to upgrade the Model 9000 software. Refer to Section 3 for contacting Silent Knight for an upgrade.

### 9.1 Silencing Notification Devices

---

External silence input is designed to silence notification devices only to protect the system from being disabled without an audible tone. To activate external silence input, press the SILENCE key or use the external silence keyswitch (Section 6.5). The on-board beeper and local annunciators (Model 5230) continue to sound, warning of the need for additional service. After a service person has checked the system, the alarm can be reset. Alarm reset will unlatch the zone and silence the on-board beeper and remote annunciators. The alarm memory can then be cleared and the system returned to normal.

To silence the on-board beeper and local annunciators, if necessary, refer to Section 7.1.3.

### 9.2 Earth Ground Fault Troubleshooting

---

#### 9.2.1 P3 and P4 Fault

A P3 trouble indicates that the control has detected a short between circuit ground and earth ground. A P4 trouble indicates a short between one of the control power terminals and earth ground.

To determine the location of the short, remove field wiring circuits until the control returns to normal operation. When the circuit that caused the trouble is found, use an ohmmeter to measure the resistance between each wire in the circuit and earth ground mounting screw (located in the bottom left corner of the PC board). The resistance should be higher than 220K ohms.

## 9.2.2 Accu-Zone, Troubleshooting (Mode 25)

Accu-Zone, Troubleshooting allows you to determine the voltage on any zone input and most system supervisory input (including AC power and battery power) without using a voltmeter. All alarms and troubles are disabled while you are using mode 25 so that you can trip sensors, adjust wiring, and so on. This mode is intended to be used with the Model 5230 Remote Annunciator as some features of zone troubleshooting are not available with the built-in touchpad.

### Using Accu-Zone Troubleshooting

1. Press 2 5 ENTER + code 0 to enter mode 25.

The first line of the display will show the channel (input) number (Table 9-1 shows which channel corresponds to each input). The second line will show a high, low, and present voltage measurement value.

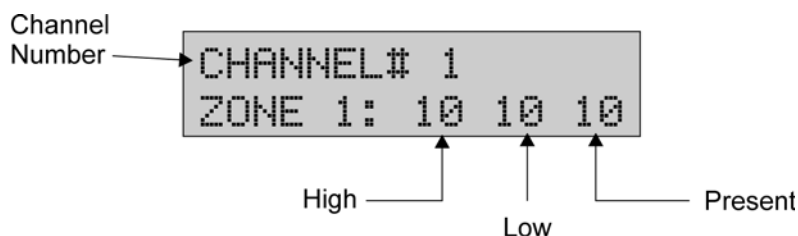

These values, or “step numbers”, are not actual voltage readings. Use the information following these steps and Table 9-1 to determine the values acceptable for each input, and to calculate the actual voltage reading.

2. The high and low values allow you to momentarily trip a zone, then come back to the touchpad and see the result. This is also useful in locating intermittent connections. If you are using the built-in touchpad, only the present voltage appears on the display.
3. Press ENTER to advance to the next channel.
4. Press STEP to skip to a different channel. For example, if you were on channel 5 and you pressed STEP, the LCD would appear as follows:

```
ENTER CHANNEL #5  
BELL 1: 23 23 23
```

Enter the channel number and press ENTER.

5. Press STEP STEP CLEAR CLEAR to exit mode 25.

The values can range from 0 to 31 and are shown in the 12-volt and 24-volt columns of Table 9-1. To arrive at the voltage reading for each terminal, use the following formula:

$$\text{Actual voltage} = \text{present step number} \times n$$

Where n = Volts per Step value (in table)

For example, if the Zone 3 reading is "3:060106", The actual voltage would be calculated as 06 X .15 = .9 V.

**Table 9-1: Mode 25 Voltage Calculations**

Channel	Zone Input	Terminal Number	Step Numbers				Volts per Step
			12-Volt Panel		24-Volt Panel		
			Valid Range	Typical Value	Valid Range	Typical Value	
1-4	Zones 1-4 (Class A (style D))	18, 20, 23, 25	4-19	5	6-24	10	0.016
5-6	Notification circuits 1-2	7-8, 9-10	10-15	12	20-28	24	0.08
7	Accessory power (+AUX)	1	-	11	-	21	1.27
8	Touchpad power (KEY+)	3	-	11	-	11	1.27
9	Smoke power (+SMK)	19, 21, 24	-	11	-	21	1.27
10	AC power	AC Connector	≥ 22	28	≥ 22	30	.90*
*For AC power measured on 120 V wiring, the Volts per Step is approximately 3.60.							
11	Battery power **	Cables	≥ 9	9	≥ 17	21	1.30
** Before taking a battery reading, disconnect AC power and put the panel into an alarm condition.							
12	Earth ground	Earth mounting screw	≤ 14 ≥ 14	8 20	≤ 14 ≥ 14	8 20	0.160

**Special Notes**

1. On Bell and Supervisory, a value below the minimum or above the maximum will cause a trouble.
2. On earth ground, the present voltage should be constantly changing between 8 and 20. If the reading does not cover this range, it could mean that the earth ground is shorting to something on the PC board.
3. Any voltage too high to measure will have the value 31. This is normal only for class B (style B) alarms.

## 9.3 Troubleshooting and System Messages





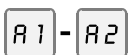





Table 9-2 shows the messages that may appear on the Model 5230 touchpad display and the codes that may appear on the 5204 built-in touchpad display.

For troubleshooting, you can connect a 5230 temporarily if it is not part of the installation (see Section 5.9).

**Table 9-2: System Messages and Codes**

5230 Message	Description or Action	Built-in Touchpad Display or LEDs
(Channel data)	A zone test is being conducted.	- 5 SET MODE LED on
(Individual option names)	The 5204 is in the Step Programming mode.	- 7 SET MODE LED on
(Cycling system messages)	Smoke power is being tested.	- 1
(Cycling system messages)	The alarm memory has just been cleared.	- 2
(Cycling system messages)	Dialer is being reset.	- 3
ALARM ZONE#	The alarm memory is being displayed.	- 5
FIRE #0 FIRE DRILL	A fire drill or system test is in progress.	- 0 SET MODE LED on ALARM LED on
ALARM ZONE 1-4	An alarm condition exists in the indicated zone.	1 - 4 ALARM LED on
DISABLE: ZONE # ZONE DESCRIPTION	Disabled (shunted or bypassed) zone. (The zone descriptions appear only if selected as a programming option.)	b1 - b4
DIALER TROUBLE	The optional dialer has tried the programmed number of times (TOTAL ATTEMPTS) and has not been able to communicate with the central station (DIALER FAILED condition). Dialer failed. The communicator has failed to report. Data lost. Communicator has lost data it was trying to transmit to the central station.	dF
WALK TEST	A walk test is being conducted. The top line of the 5230 display may also show the zone number in the trouble condition.	- 2 SET MODE LED on
PRE-ALARM ZONE X ZONE LOCATION	An alarm condition exists in the indicated zone, but will not sound and report alarm until pre-alarm time has elapsed. During pre-alarm time, pressing RESET ALARM ENTER (code 1 or 0) will prevent sounding and reporting.	
REPORTING	An event is being reported to the central station.	REPORT LED flashes

**Table 9-2: System Messages and Codes**

5230 Message	Description or Action	Built-in Touchpad Display or LEDs
SILENCED	A trouble condition exists and the annunciator has been turned off.	SILENCE LED on
SMOKE ZONE #	Smoke verification time, zone 1-4.	 d1 - d4
SPRINKLER # ZONE DESCRIPTION	Sprinkler supervisory alarm.	 c1 - c4
SYSTEM NORMAL	No trouble, alarm, or other condition exists.	--
TIME?	The 5204 is in the Set Time mode.	 -9 SET MODE LED on
LOW AC	AC power has been lost. Check connection to AC power source.	 AC TROUBLE LED on AC/DC flashes
LOW BATTERY	Battery power has been lost, or polarity has been reversed. Measure the battery voltage and replace the battery or reverse polarity if necessary.	 DC TROUBLE LED on AC/DC flashes
TROUBLE BELL #1/#2	A trouble condition exists on the indicated notification device.	 R1 - R2 TROUBLE LED on
TROUBLE GROUND	An earth to circuit ground fault condition exists. Use mode 25 to locate and correct the condition. Earth ground shorted to power. Use mode 25 to locate and correct the problem.	 P3 TROUBLE LED on  P4 TROUBLE LED on
TROUBLE REMOTE #	One or more of the Model 5230 annunciators is in trouble.	F1 - F3 TROUBLE LED on
TROUBLE TROUBLE ZONE #	Sprinkler supervisory trouble.	 c1 - c4 TROUBLE LED on
TROUBLE LINE 1	A trouble condition exists on phone line 1.	 L1 TROUBLE LED on
TROUBLE LINE 2	A trouble condition exists on phone line 2.	 L2 TROUBLE LED on
TROUBLE ZONE #1-#4 (Zone location on second line of LCD.)	A trouble condition exists in the indicated zone. Refer to Section 9.2.2 to find and correct the trouble condition.	 1 - 4 TROUBLE LED on
TRY AGAIN	A keystroke error has been made. Press CLEAR) and enter the correct keystrokes.	---
TROUBLE COM 1	Unable to report manual or auto test using line 1.	L1 TROUBLE LED on.
TROUBLE COM 2	Unable to report manual or auto test using line 2.	L2 TROUBLE LED on.
UNDEFINED #	Alarm condition on undefined type zone.	U1 - U2 ALARM LED on.

When the 5230 annunciator is powered up, it will show its ID number (1, 2, or 3) followed by the cycle of messages describing conditions that are currently in effect.

While the 5204 is communicating with the central station, the LCD will show the following message:

(Cycling Message)

REPORTING

If two or more zones are in alarm, the top line will cycle through the status messages for these zones.

When the transmission is completed, the 5230 annunciator memory is reset (cleared) and the annunciator ID number is displayed.

---

## Section 10

# Central Station Reporting

---

---

### 10.1 Power Loss Reporting

---

The 5204 monitors both AC and battery power. The AC report delay time can be programmed in the range of 6-15 hours. An AC power-loss condition will cause the audible trouble condition to sound and the green LED to flash on and off. The 5205 will report the trouble to the central station (after the programmed delay time).

For NFPA Central Station Fire Alarm systems, AC report time must be 6-12 hours.

For NFPA Remote Station Protected Fire Alarm systems, AC report time must 15 hours.

### 10.2 Reporting Formats

---

The Model 5204 can transmit information in the following formats. The type of format you select is determined by the type of receiver used at the central station (see Section 8.4.38).

SIA8 and SIA20	Security Industry Association standard.
Silent Knight 3/1	Old format, transmits a 3-digit account number and a 1-digit alarm code. Transmissions are acknowledged at 1400 Hz.
Sescoa 3/1	Old format, transmits a 3-digit account number and a 1-digit alarm code. Transmissions are acknowledged at 2300 Hz.
Silent Knight 4 + 2	Silent Knight tone burst format, transmits a 4-digit account number and a 2-digit alarm code.
Silent Knight FSK	High-speed, single-round format for use with the Model 9000 and older receivers. Transmits a 4-digit account number and 2-digit alarm code.

The tables in the following sections show the digits that are transmitted for each event reported by the 5205 dialer, and the message printed out by the Model 9000 receiver at the central station.

#### Caution

Some formats do not distinguish between certain types of reports, such as between waterflow and fire alarms, or between supervisory and trouble reports. The central station must keep records of how the various zones are programmed at each account, so they can determine what condition is being reported for a particular zone.



## 10.2.1 SIA Format Printed Messages

In the SIA8 and SIA20 formats, the 5204 transmits the English description shown in the first column of Table 10-1. At the central station, the 9000 receiver prints the English message shown in the second column.

**Table 10-1: 9000 Printout for SIA Format**

5204 Dialer Condition	9000 English Language Printout
Alarm 1-4	“FIRE” ALARM 1-4 *
Alarm Restore 1-4	“FIRE” ALARM RESTORE 1-4 *
Disable 1-4	“FIRE” SHUNTED 1-4 *
Disable Restore 1-4	“FIRE” SHUNT RESTORE 1-4 *
Trouble 1-4	“FIRE” TROUBLE 1-4 *
Trouble Restore 1-4	“FIRE” TROUBLE RESTORE 1-4 *
AC Lost	A.C. TROUBLE 0
AC Restore	A.C. RESTORE 0
Battery Trouble	TROUBLE 09
Battery Restore	LOW BATTERY 0
Manual Test	BATTERY RESTORE 0
Automatic Test	AUTO TEST 0
Fire Drill	MANUAL TEST
Downloading succeeded*	PROGRAMMING PASS 0 **
Downloading failed*	PROGRAMMING FAIL 0 **
Phone Line #1 Trouble	PHONE LINE TROUBLE 1
Phone Line #2 Trouble	PHONE LINE TROUBLE 2
Annunciator # 1-3 Trouble	EXPANSION TROUBLE 17-19
Bell #1 Trouble	EXPANSION TROUBLE 32
Bell #2 Trouble	EXPANSION TROUBLE 33
Earth Ground Trouble, Ground	EXPANSION TROUBLE 38
Earth Ground Trouble, Power	EXPANSION TROUBLE 39
Data Lost	DATA LOST 0
Phone Line #1 Restore	PHONE LINE RESTORE 1
Phone Line #2 Restore	PHONE LINE RESTORE 2
Annunciator # 1-3 Restore	EXPANSION RESTORE 17-19
Bell #1 Restore	EXPANSION RESTORE 32
Bell #2 Restore	EXPANSION RESTORE 33
Earth Ground Restore, Ground	EXPANSION RESTORE 38
Earth Ground Restore, Power	EXPANSION RESTORE 39

\* All zones can be programmed as FIRE, WATERFLOW, UNDEFINED, or SPRINKLER. Fire is used as an example in the 9000 printout column above; the actual word printed will be whatever zone type has been programmed (see Steps 6-9 in Section 8).

\*\*The 9000 must have the Model 9307 software package, Revision 900501 or later, to print the PROGRAMMING PASS and PROGRAMMING FAIL messages.

## 10.2.2 Silent Knight 3/1 and Sescoa 3/1 Formats

These formats transmit a 3-digit account number and a single-digit alarm code. These two formats greatly limit the amount of information that can be reported. To avoid confusion at the central station, standard alarm digits should be chosen. During programming, you select which alarm digits will be reported for different events. You can choose not to report restores or not to use zone numbers that might be duplicated by a supervisory transmission.

The second column in Table 10-1 shows the programming step number in which each digit is programmed. The third column indicates the 9000 prints only the digit (X) that has been programmed for that event - NOT an English message.

*Note: When using the 3/1 formats, many of the reporting capabilities are lost because of the limited number of codes that can be sent.*

**Table 10-2: Printout for Silent Knight and Sescoa 3/1 Formats**

5204 Dialer Condition	Programming Step Number	9000 Printout
Alarm 1-4	55	CODE X = ALARM
Alarm Restore 1-4	58	CODE X = RESTORE
Disable 1-4	57	CODE X = DISABLE
Disable Restore 1-4	58	CODE X = RESTORE
Trouble 1-4	56	CODE X = TROUBLE
Trouble Restore 1-4	58	CODE X = RESTORE
AC Lost	56	CODE X = TROUBLE
AC Restore	58	CODE X = RESTORE
Battery Trouble	56	CODE X = TROUBLE
Battery Restore	58	CODE X = RESTORE
Manual Test	59	CODE X = TEST
Automatic Test	59	CODE X = TEST
Fire Test	59	CODE X = TEST
Downloading succeeded*	59	CODE X = TEST
Downloading failed*	59	CODE X = TEST
Phone Line #1 Trouble	56	CODE X = TROUBLE
Phone Line #2 Trouble	56	CODE X = TROUBLE
Annunciator # 1-3 Trouble	56	CODE X = TROUBLE
Bell #1 Trouble	56	CODE X = TROUBLE
Bell #2 Trouble	56	CODE X = TROUBLE
Earth Ground Trouble	56	CODE X = TROUBLE
Data Lost	59	CODE X = TEST
Phone Line #1 Restore	58	CODE X = RESTORE
Phone Line #2 Restore	58	CODE X = RESTORE
Annunciator # 1-3 Restore	58	CODE X = RESTORE
Earth Ground Restore	58	CODE X = RESTORE
Bell #1 Restore	58	CODE X = RESTORE
Bell #2 Restore	58	CODE X = RESTORE

\* A test report might indicate that the 5204 has been downloading.

### 10.2.3 Silent Knight FSK and 4+2 Formats

The Silent Knight FSK and 4 + 2 formats transmit a 4-digit account number and a 2-digit alarm code. When an event is reported in either of these two formats, the dialer transmits the two digits shown in the second column. The 9000 can be programmed to print either the two digits or the English message shown in the third column of Table 10-3. If you are using the 9032 line card, FSK2 and BFSK are the only formats that will report in English.

#### Caution

Do NOT use the FSK or 4 + 2 formats when using the uploading or downloading functions. These formats do not distinguish between different types of tests (see Table 10-3).

**Table 10-3: 9000 Printout for FSK & SK 4+2 Codes**

5204 Dialer Condition	Digits Transmitted	9000 English Language Printout (9002 Line Card)
Alarm 1-4	01-04	ALARM 01 - ALARM 04
Alarm Restore 1-4	21-24	ALARM RESTORE 01 - 04
Disable 1-4	51-54	SHUNT 11 - 14
Disable Restore 1-4	21-24	ALARM RESTORE 11 - 14
Trouble 1-4	61-64	TROUBLE 01 - TROUBLE 04
Trouble Restore 1-4	71-74	RESTORE 01 - RESTORE 04
AC Lost	60	A.C. TROUBLE
AC Restore	70	A.C. RESTORE
Battery Trouble	69	LOW BATTERY
Battery Restore	79	BATTERY RESTORE
Manual Test	30	TEST
Automatic Test	30	TEST
Fire Test	30	TEST
Downloading succeeded*	30	TEST
Downloading failed*	30	TEST
Phone Line #1 Trouble	31	PHONE LINE TROUBLE 01
Phone Line #2 Trouble	32	PHONE LINE TROUBLE 02
Annunciator # 1-3 Trouble	33	EXPANSION TROUBLE
Bell #1 Trouble	33	EXPANSION TROUBLE
Bell #2 Trouble	33	EXPANSION TROUBLE
Earth Ground Trouble	33	EXPANSION TROUBLE
Data Lost	39	DATA LOST
Phone Line #1 Restore	35	PHONE LINE RESTORE 01
Phone Line #2 Restore	36	PHONE LINE RESTORE 02
Annunciator # 1-3 Restore	37	EXPANSION TROUBLE
Earth Ground Restore	37	EXPANSION TROUBLE
Bell #1 Restore	37	EXPANSION TROUBLE
Bell #2 Restore	37	EXPANSION TROUBLE

\* A test report might indicate that the 5204 has been downloading.

## 10.2.4 Radionics BFSK Format

The Radionics BFSK format transmits the event descriptions shown in the first column of Table 10-4. The second column shows the English message that the 9000 receiver prints at the central station.

**Table 10-4: 9000 Printout for Radionics BFSK Format**

<b>5204 Dialer Condition</b>	<b>9000 English Language Printout</b>
Alarm 1-4	ALARM 01 - ALARM 04
Alarm Restore 1-4	RESTORE 01 - RESTORE 04
Disable 1-4	TROUBLE 01 - TROUBLE 04 / FORCE ARMED
Disable Restore 1-4	RESTORE 01 - RESTORE 04
Trouble 1-4	TROUBLE 01 - 04
Trouble Restore 1-4	RESTORE 01 - 04
AC Lost	TROUBLE 00
AC Restore	RESTORE 00
Battery Trouble	TROUBLE 09
Battery Restore	RESTORE 09
Manual Test	RESTORE 0E
Automatic Test	RESTORE 0E
Fire Test	RESTORE 0E
Downloading succeeded*	RESTORE 0F
Downloading failed*	TROUBLE 0F
Phone Line #1 Trouble	TROUBLE 0B
Phone Line #2 Trouble	TROUBLE 0C
Annunciator # 1-3 Trouble	TROUBLE 0D
Bell #1 Trouble	TROUBLE 0D
Bell #2 Trouble	TROUBLE 0D
Earth Ground Trouble	TROUBLE 0D
Data Lost	TROUBLE 0E
Phone Line #1 Restore	RESTORE 0B
Phone Line #2 Restore	RESTORE 0C
Annunciator # 1-3 Restore	RESTORE 0D
Earth Ground Restore	RESTORE 0D
Bell #1 Restore	RESTORE 0D
Bell #2 Restore	RESTORE 0D

\* In Radionics BFSK format, the 9000 does not print alarm type, just the words *ALARM*, *TROUBLE*, etc.



# Appendix A

## Programming Quick Reference

The quick reference table in this appendix briefly describes all of the available programming options and lists the factory-programmed default values that come with the Model 5204 panel. The 5204 can be programmed from a Model 5230 Remote Annunciator or with the Model 5541 downloading software.

For each programming option, the quick reference table identifies the menu or step to use for whichever programming method you choose. The table also provides an area for you to write in your selections before you begin programming. For more detailed information about a particular programming option, page references are included.

**Table A-1: Quick Reference Table**

Option	Default	Your Selection	5230 Step #	5541 Menu	Page #
<b>Annunciator Operation</b>					
Maximum Number of Supervised 5230s	0		3	B	8-7
Current Time Displays on LCD	Blank		76	Through Request Status	8-26
<b>Bell and Other Audible Signaling Options</b>					
External Silence Delay	Yes		2	B	8-7
Bell #1 Silence	No		34	D	8-16
Bell #2 Silence	No		39	D	8-17
Bell #1 Output Pattern (zones 1-4)	Steady		35-38	D	8-16
Bell #2 Output Pattern (zones 1-4)	Steady		40-43	D	8-17
Sound Smoke Delay	No		24	B	8-14
<b>Device Enables</b> - Enabling devices used with the 5204.					
Enable Computer	Yes		47	E	8-18
Enable Dialer	No Dialer		46	E	8-18
<b>Dialer and Reporting Options</b>					
Dialer Type	No Dialer		46	E	8-18
Central Station Phone Number 1	Blank		67	E	8-23
Central Station Phone Number 2	Blank		72	E	8-25
Central Station Account Number 1	005204		65	E	8-22
Central Station Account Number 2	005204		69	E	8-24
Events Reported to Central Station:					
3/1 Alarm code	1		55	E	8-21
3/1 Trouble code	8		56	E	8-21
3/1 Sprinkler code	2		57	E	8-21

**Table A-1: Quick Reference Table**

Option	Default	Your Selection	5230 Step #	5541 Menu	Page #
3/1 Disable code	5		58	E	8-21
3/1 Restore code	7		59	E	8-21
3/1 Test code	9		60	E	8-21
Computer Account Number (For uploading or downloading.)	005204		73	E	8-25
Computer Phone Number (For uploading or downloading.)	Blank		74	E	8-25
Fail Attempts for Account #1 (Number of attempts before local annunciation of DIALER TROUBLE condition.)	3		66	E	8-23
Fail Attempts for Account #2 (Number of attempts before local annunciation of DIALER TROUBLE condition.)	3		70	E	8-24
Number of Rings to Activate Downloading	10		54	E	8-20
Ground Start	No		48	E	8-19
Low AC Delay (hrs)	6		53	E	8-20
Telephone Number To Report:					
Alarm #1 1st	Yes		61	E	8-21
Trouble #1 1st	Yes		62	E	8-22
Disabled Zones (Shunted Zones) #1 1st	Yes		63	E	8-22
Test #1 1st	Yes		64	E	8-22
Must Report #1	Yes		51	E	8-19
Must Report #2	No		52	E	8-20
Touch-tone Line 1	No		49	E	8-19
Touch-tone Line 2	No		50	E	8-19
Dialer Format #1	SIA 8		67	E	8-23
Dialer Format #2	SIA 8		71	E	8-25
<b>General Purpose Relay #2 Options</b>					
Relay #2 Usage	Alarm		33	D	8-16
<b>Secret Code Options</b>					
Code #0 (Installer's code) (Access to all functions.)	5204		44	D	8-18
Code #1 (Main user's code) (Access to all functions except programming.)	1111		45	D	8-18
<b>System Options - Options that control overall function of 5204.</b>					
24 Volt Smoke Power	24V=Yes 12V=No		1	B	8-7
Current Time Displays on LCD	Blank		76	Through Request Status	8-26
System (Troubleshooting) Messages	See Sect. 9.3		N/A	N/A	9-4
<b>Test Options</b>					

**Table A-1: Quick Reference Table**

Option	Default	Your Selection	5230 Step #	5541 Menu	Page #
Test Time	01:30		75	E	8-26
Report Tests to Telephone #1 1st	Yes		64	B	8-22
<b>Timer Options</b>					
Smoke Reset Time	2 sec.		4	B	8-8
Test Time	01:30		75	E	8-26
Pre-Alarm Time	5 sec.		18	B	8-14
Smoke Verification Time	6 sec.		23	B	8-14
<b>Zone Options</b>					
Zone Type (zones 1-4)	Fire		6-9	B	8-8
Zone Response Speed (zones 1-4)	.3 - .4 sec.		29-32	B	8-15
Pre-Alarm Delay (zones 1-4)	No		19-22	B	8-14
Pre-Alarm Time (zones 1-4)	5		18	B	8-14
Smoke Verification Delay	6		23	B	8-14
Smoke Verify (zones 1-4)	No		25-28	B	8-15
Allow Zone Disable	Yes		5	B	8-8
Zone Location Description (zones 1-4)	Blank		10-13	C	8-9
Cross Alarm (zones 1-4)	No		14-17	B	8-10





# Silent Knight Fire Product Warranty and Return Policy

---

## General Terms and Conditions

- All new fire products manufactured by Silent Knight have a limited warranty period of 18 months from the date of manufacture against defects in materials and workmanship. See limited warranty statement for details.
- This limited warranty does not apply to those products that are damaged due to misuse, abuse, negligence, exposure to adverse environmental conditions, or have been modified in any manner whatsoever.

## Repair and RA Procedure

- All products that are returned to Silent Knight for credit or repair require a RA (Return Authorization) number. Call Silent Knight Customer Service at 800-446-6444 or 763-493-6435 between 8:00 A.M. and 4:45 P.M. CST, Monday through Friday to obtain a return authorization number. Silent Knight Technical Support is available at 800-328-0103 between 8:00 A.M. and 6:00 P.M. CST, Monday through Friday.
- RA number must be prominently displayed on the outside of the shipping box. See return address example under Advanced Replacement Policy.
- Include a packing slip that has the RA number, a content list, and a detailed description of the problem should be included with each return.
- All products returned to Silent Knight must be sent freight pre-paid. After product is processed, Silent Knight will pay for shipping product back to customer via UPS ground.
- Return the Silent Knight product circuit board only. Products that are returned in cabinets will be charged an additional \$50 to cover the extra shipping and handling costs over board only returns. **Do not return batteries.** Silent Knight has the authority to determine if a product is repairable. Products that are deemed un-repairable will be returned to the customer.
- Product that is returned that has a board date code more than 18 months from date of manufacture will be repaired and the customer will be assessed the standard Silent Knight repair charge for that model.

## Advanced Replacement Policy

- Silent Knight offers an option of advance replacement for fire product printed circuit boards that fail during the first 6 months of the warranty period.
- For advance replacement of a defective board contact your local Silent Knight Distributor or call Silent Knight at 800-446-6444 or 763-493-6435 to obtain a RA (Return Authorization) number and request advanced replacement.
- Customers without a Silent Knight account must use a MasterCard, Visa, or American Express credit card to get an advance replacement.

- A new or refurbished board will be shipped to the customer. The customer will initially be billed for the replacement board but a credit will be issued after the repairable board is received at Silent Knight. All returned products must comply with the guidelines described under “General Terms and Conditions”.
- The defective board must be returned within 30 days of shipment of replacement board for customer to receive credit. No credit will be issued if the returned board was damaged due to misuse or abuse.
- Repairs and returns should be sent to:

Silent Knight

Attn: Repair Department

7550 Meridian Circle Suite 100

Maple Grove, MN 55369-4927

RA Number: \_\_\_\_\_

### **Limited Warranty**

Silent Knight warrants that the products of its manufacture shall be free from defects in materials or workmanship for 18 months from the manufacturing date code on the printed circuit board, if such goods have been properly installed, are subject to normal proper use, and have not been modified in any manner whatsoever. Upon return of the defective product, Silent Knight will at its sole discretion, either repair or replace, at no cost, such goods as may be of defective material or workmanship. Customers outside the United States are to return products to their distributor for repair.

SILENT KNIGHT SHALL NOT UNDER ANY CIRCUMSTANCES BE LIABLE FOR ANY INCIDENTAL OR CONSEQUENTIAL DAMAGES ARISING FROM LOSS OF PROPERTY OR OTHER DAMAGE OR LOSSES OWING TO THE FAILURE OF SILENT KNIGHT PRODUCTS BEYOND THE COST OF REPAIR OR REPLACEMENT OF ANY DEFECTIVE PRODUCTS.

SILENT KNIGHT MAKES NO WARRANTY OF FITNESS OR MERCHANTABILITY AND NO OTHER WARRANTY, ORAL OR WRITTEN, EXPRESS OR IMPLIED, BEYOND THE 18 MONTH WARRANTY EXPRESSLY SPECIFIED HEREIN.



7550 Meridian Circle  
Maple Grove, MN 55369-4927  
612-493-6455  
1-800-328-0103  
Fax: 612-493-6475

© 2001 Silent Knight  
Part Number 150644C, 6/01